

Height Adjustable Standing Desk

Dual Lifting Column Three Segments

User Guide

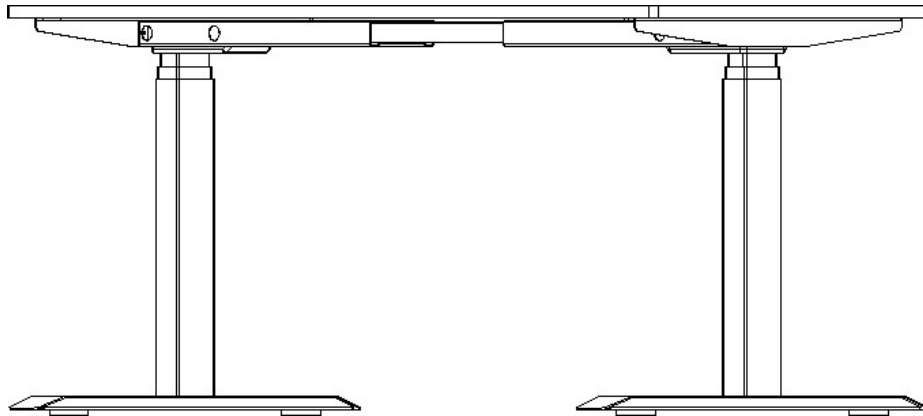

WARNING:

Make sure there are no obstacles on the desk; all wire lengths are suitable for table movement; failure to observe or violate assembly instructions, safety rules, operation manuals, and product use-related warnings may result in serious property damage and personal injury.

IMPORTANT : All users or installers must study this manual carefully. If the table is sold, this manual must be attached.

Content	Page
1. Safety warning	1
2. Usage	2
3. Set up & install	2
4. Accessories	2
5. Assembly instruction	3
6. Specification	4
7. Fault description	4

1. Safety warning

- Improper use of this product may cause personal safety
- Please keep electronic control device environment dry.
- Please arrange the power cord reasonably, not cluttered, to avoid to be tripped.
- Do not stand on the table when the table is running or stationary to avoid injury.

2. Usage

- Height-adjustable table contains an electric motor, suitable for dry working areas.
- Please set desk height at the most ergonomically appropriate height.
- Do not drag or place the table upside down, and strictly forbidden to sit or stand on the table shelf.
- Minors cannot use this product without supervision.
- In any case, except for the description in this operation manual, the manufacturer will not accept warranty claims and compensation liabilities caused by incorrect use.

3. Set up & install

Adjust and fix the foot pads put the table placed horizontally,also ensure there is enough space, and safe distance from the doors, windows, and various furniture,home appliances,do not place objects larger than 50cm (20 inches) under the table ,then checking power cord is not damaged, connect it to the 110V or 220V power supply. After assembly, when you want to move the table, do not lift the desktop board alone when ,that will cause damage to the fasteners connecting the parts and the table.

4. Accessories

Tools: Wrench

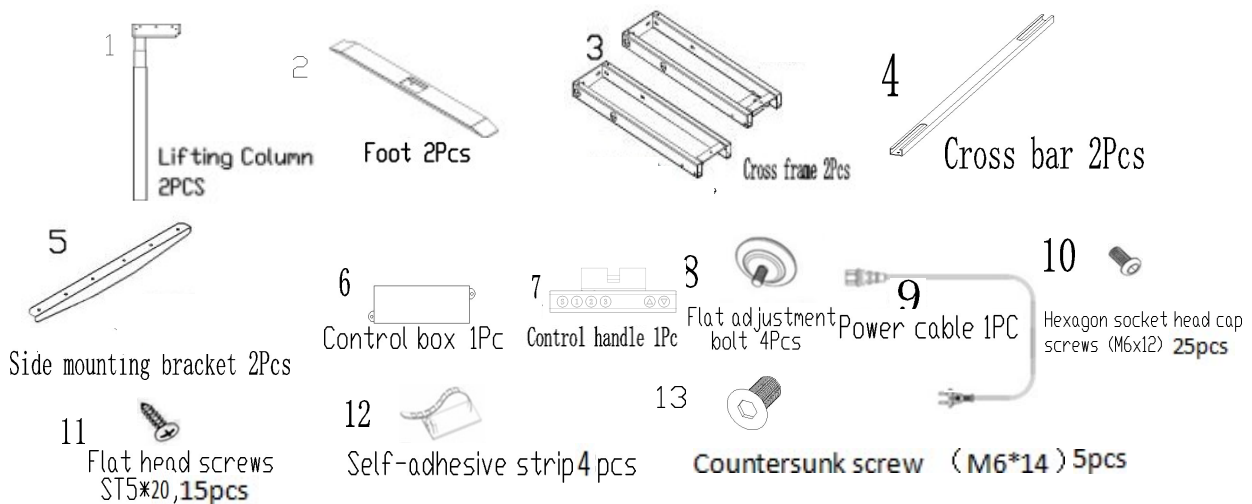
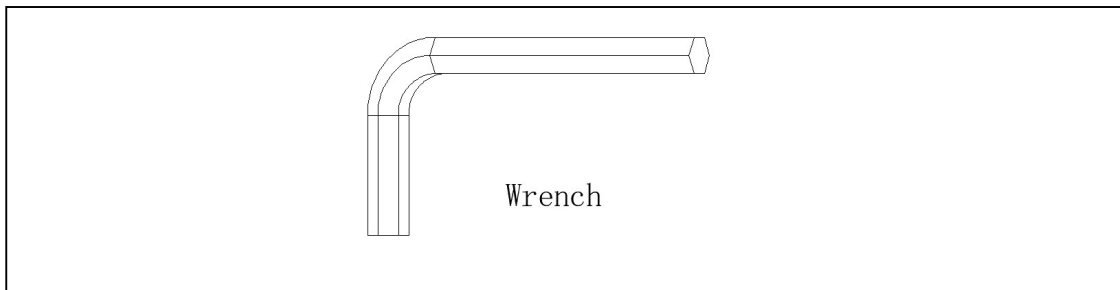

After unpacking, please check the list according to this manual, and count all the accessories. Please assemble in areas with pads or carpets to avoid damage. For convenience and safety, we recommend that 2 people assemble together.

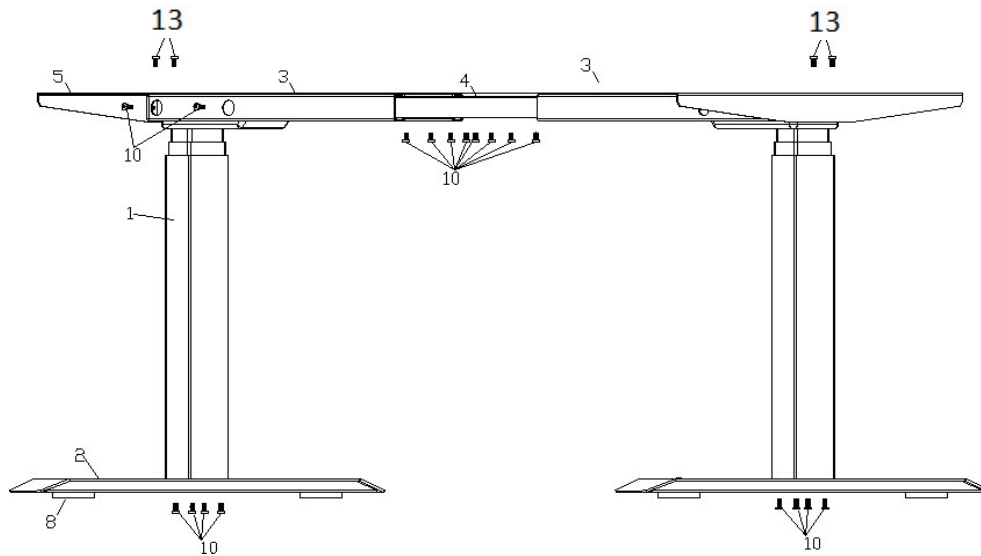

No.	Item	Qty
1.	Lifting column	2Pcs
2.	Foot	2Pcs
3.	Cross frame	2Pcs
4.	Cross bar	2Pcs
5.	Side mounting bracket	2Pcs
6.	Control box	1Pc
7.	Control handle	1Pc
8.	Flat adjustment bolt	4Pcs
9.	power cable	1pc
10.	Round cup hexagon screw (M6*12)	25Pcs
13.	Countersunk screw (M6*14)	5Pcs

5. Assembly instruction

First, show all the components and hardware to ensure that all the accessories meet the above list of accessories. Fix The Side mounting bracket(item5) and the cross frame (Item3) Insert 4pcs Countersunk screw(item13), and use wrench to rotate each screw .

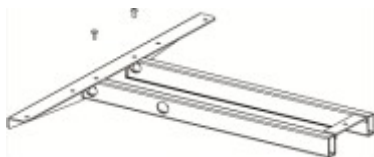

The cross bar (Item 4) is placed in the middle of the cross frame (Item3).Insert 4pcs hexagon socket screws M6x12 (Item 10) through the 4 holes of the cross frame (Item 3) into the corresponding holes of the lifting column (Item 1), and use wrench to rotate each screw only 3 times.

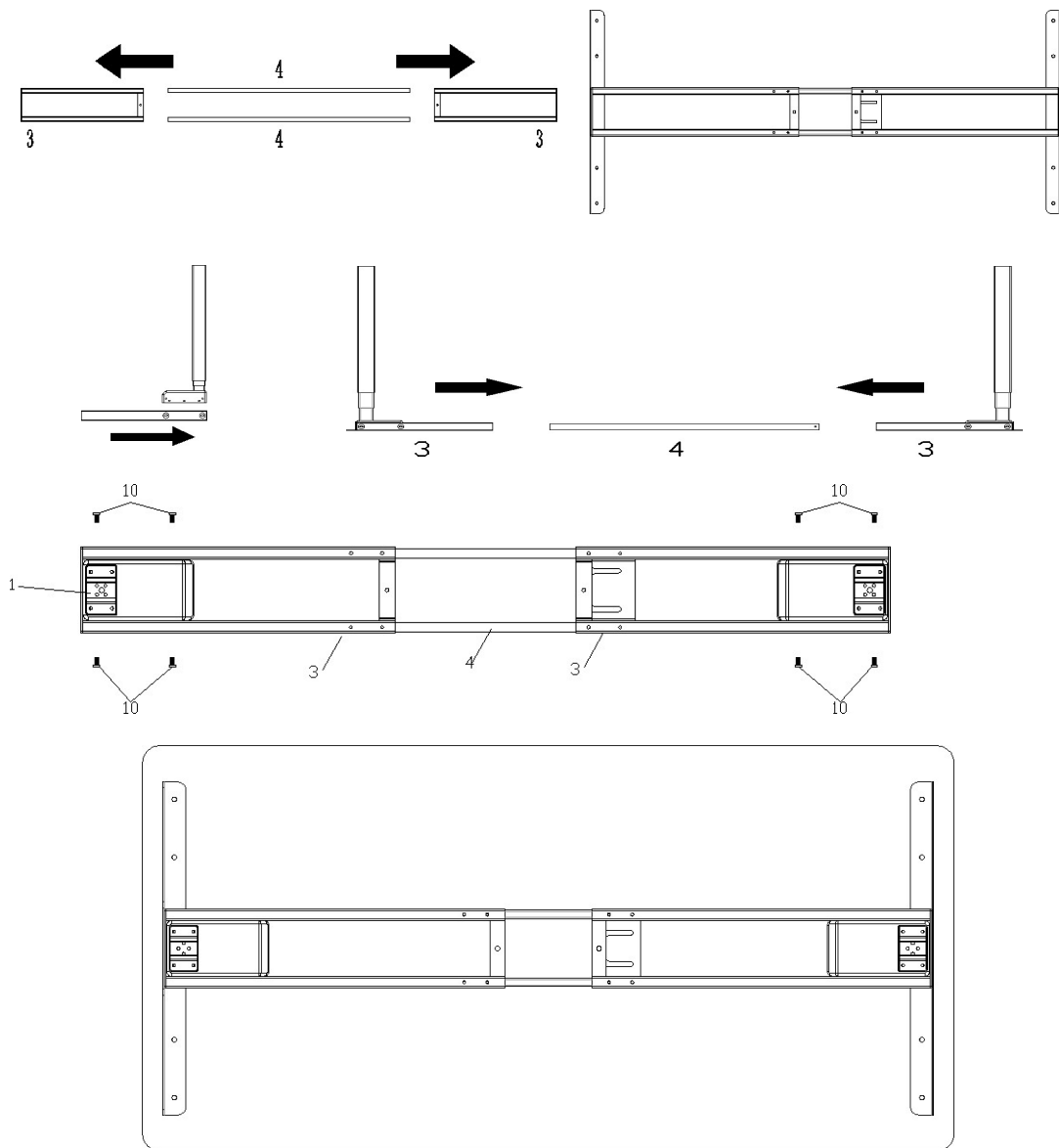

Fix the lifting column (Item 1) in the hole next to the cross frame (Item 3) then lined up.

A. **IMPORTANT!** Don't fix the screws at this step, just insert them and rotate 3 times ,you will tighten in step D.

! Don't tighten the M6x12 hexagon socket screws (Item 10), only need to turn 3 times

! If the screws fall into the cross frame, just tilt the horizontal frame and remove the screws.

B. **IMPORTANT!** Don't fix the screws in this step, just plug them in and rotate 3 times. We tighten at step D.

Insert 4pcs M6x12 hexagon socket head cap screws (Item 10) into the horizontal frame through the side mounting bracket, using wrench turn the screw 3 times.

! If you have trouble fixing the screw, it is because the screw was tight you need to go back to the previous step and loosen.

C. Once all the screws have been placed, the hexagon socket flat head screws M6x12 (Item 10) can be prohibited, and each screw should be secured in place when tightening.

D. Slide the crossbar (Item 4) into the cross frame (Item 3), making sure that the groove of the crossbar is inward. At the same time, we must pay attention to the average length of the lap of the cross bar (Item 4) and the cross frame (Item 3).

Fix the foot (Item 2) and the lifting column with 4pcs hexagon socket head screws M6x12(Item 10).

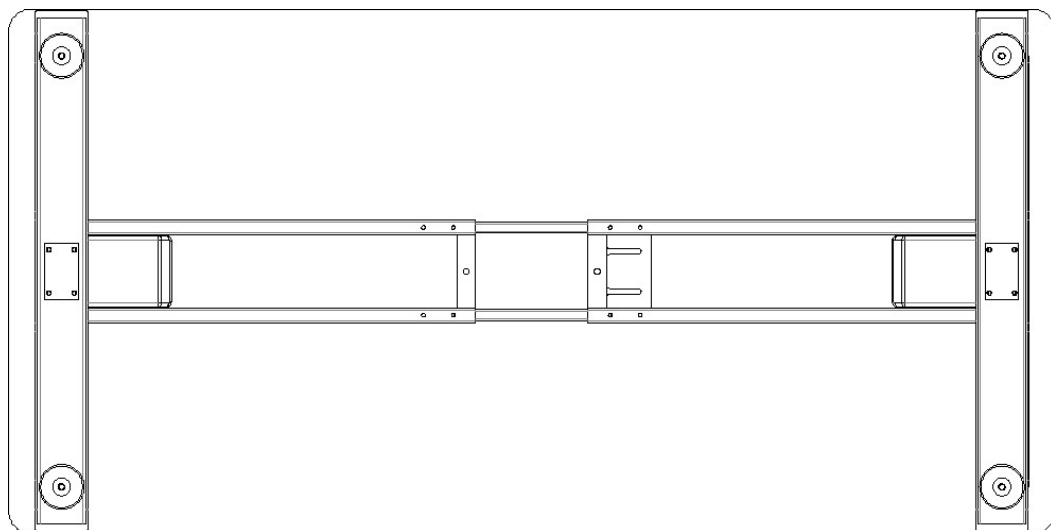
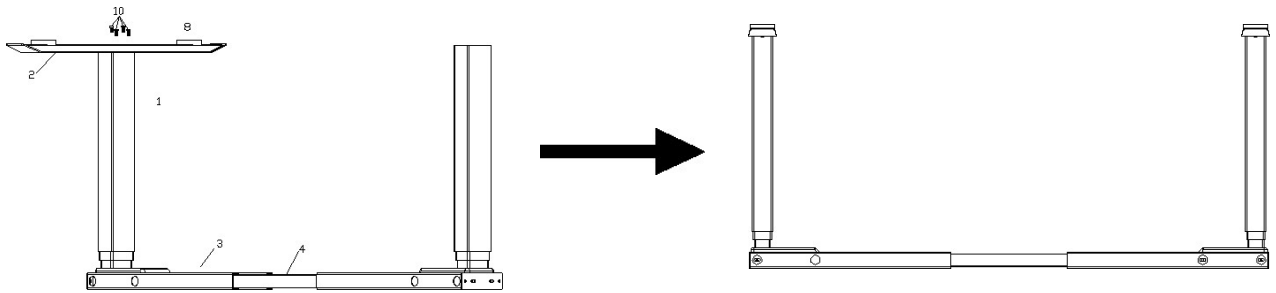

Your desktop may not be pre-drilled. Before placing the table under the table stand, please check whether there are holes on both sides of the desktop. The desktop should be carefully placed under the table stand. Note: Minimum top size: 110cm (43 ") width x 60cm (24") depth

Adjust the width of the cross bar to make it fit the desktop by sliding the cross frame,101cm (40 ") -180cm (71")max

Set the length of the cross frame you want. Some people want to put the side mounting bracket along the edge of the table. We suggest keeping a distance of at least 5cm (2 ") from each side ,make the width of the desktop over the width of the cross frame.



Use the edge of the desktop as a reference point and center the frame. Cannot use the screw hole as a reference to measure the metal bracket.

Fix the cross bar with 8 hexagon socket screws M6x12 (Item 10), 4pcs of each end.



Make sure the screws hit the metal center rail when sliding the crossbar as needed



Make sure again the cross frame is in the center below the desktop and in the area you want to place. At the same time, it was repeatedly confirmed that the self-tapping screw did not penetrate the desktop after being in place.

We suggest that drill holes for fixing the frame and desktop in advance.



Do not use countersunk screws to secure the desktop, that will damage the desktop. Make sure that any screws used will not pierce the desktop and cause damage

Now fix the table top and the table top and tighten with 8 Phillips flat head screws ST5x20 (Item 11)

Installation items as follows:

Left side mounting brackets 3pcs

Right side mounting bracket 3pcs

Left cross frame 1pc

Right cross frame 1pc

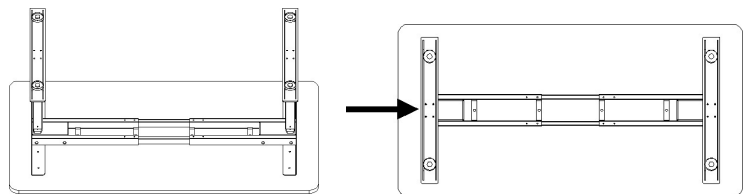

In this step, do not over-tighten the screws. Overtightening may cause the plastic parts to crack.

We suggest drill holes to secure the controller to the table in advance that will make it easier for the screw to penetrate.



Never use countersunk screws to secure the desktop. This will cause strong pressure to the desktop. Make sure that any screws used will not damage the desktop

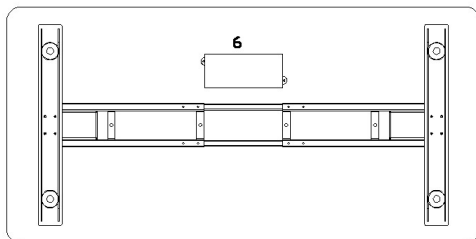

Use 2 flat head screws ST5x20 (Item 11) to fix the controller (Item 6). Make sure there is enough space for wire connection.

In this step, do not over-tighten the screws. Over-tightening may cause the plastic parts to crack.

When placing the control handle, the front of the control handle should be flush with the front edge of the desktop. The control handle can be placed anywhere on the front edge of

the desktop, but we suggest placing it next side, so that it will not affect you when you sitting move your legs.

Use two flat head screws ST5x20 (Item 11) to fix the control handle (Item 7) to the side of the desktop.

Connect the wires according to the figure below. Use self-adhesive cable ties to fix the cables so that the cables are not cluttered

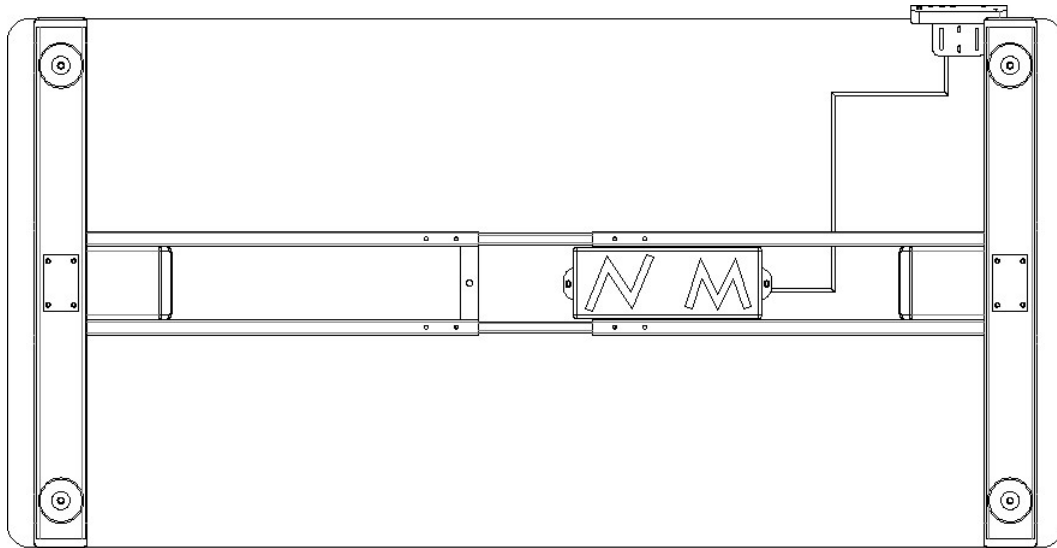

Lift the right side of the assembled table. Together, grab the table stand instead of the table top, then lift the right side of the table to adjust the level bolts of the feet.

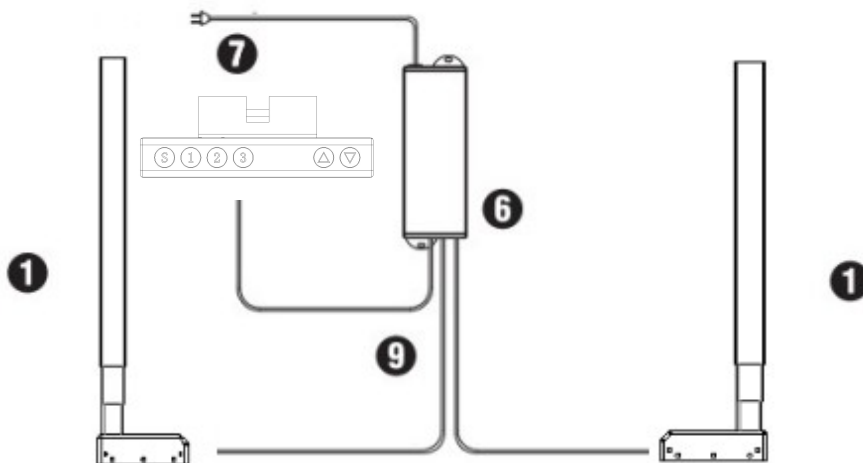



Make sure there are no obstacles around the table and all line lengths adapt to changes in height.

F. Insert the power plug into the 110V or 220V socket.

Controlling System Manual Instruction

1. Lifting

The desk will go up and down when pressing  or , along with the number shown on the height interface changing.



2. Position Invoking and Memory

The following operations are performed under the height display interface.

A. WN18H45 Touch Key Handle





It shows "H1" when pressing , then the desk will run to the sitting position when loosen it.

It shows "H2" when pressing , then the desk will run to the standing position when loosen it.

Press  and loosen it, height interface blinks, then press  and loosen it to save the current height to sitting position at last. Or press  and loosen it to save the current height to standing position at last. It will stop blinking and exit memory mode if there is no numeric key pressed within 6seconds.

B. Others

Press numeric key to invoke its corresponding height, and the desk will run to the position you invoked automatically.

Press  and loosen it, height interface blinks, then press numeric key(, , , ) to save the current height to the corresponding position. It will stop blinking and exit memory mode if there is no numeric key pressed within 6 seconds.

3. Screen Awaken

A. WN18H45 Touch Key Handle

The height interface will be closed after lightening for a long time in order to avoid contacting by mistake. You can long press  to awaken it.

B. Others

The height interface will be closed after lightening for a long time. You can press any key to awaken it.

4. Setup Mode

A. press  3 seconds, handle shows "S--" and blinks.

B. loosen  and press again to enter setup mode, it will display the function name, the function can be listed as the followings:

- Unit of the height dispalyed on the screen: Unit ();
- Brightness of the screen: Brightness (br);
- On-off state of the beep: Beep (bEE);
- Force of the collision protection: Collision Force (CF);
- Setting of the use height limitation: Set Height (SH);

□ Setting of the demonstration mode: Demo (dE)

The function of each key in the setting mode:

⏪ / ⏩ Backspace key (back to previous menu)

⬆️ ⬇️ Tab switch

Ⓜ️ Enter key (enter to next menu or confirm the current operation)

It will exit setting mode if there is no numeric key pressed within 20seconds

Main menu interface	Submenu interface	Description	
U _n Unit	S1 SI Metric	The interface displays last height unit setting after entering. Use ⬆️ or ⬇️ to choose the height unit, and press Ⓜ️ to confirm and save it. The system will exit after 2 seconds.	
	I _n Inch		
br Brightness	L Low	The interface displays last handle brightness setting after entering. Use ⬆️ or ⬇️ to choose the brightness level, and press Ⓜ️ to confirm and save it. The system will exit after 2 seconds.	
	n Normal		
	H High		
bEE Beep	OFF Off	The interface displays last buzzer setting after entering. Use ⬆️ or ⬇️ to choose the buzzer condition, and press Ⓜ️ to confirm and save it. The system will exit after 2 seconds.	
	On On		
CF Collision Force	OFF Off	The interface displays last collision force after entering. Use ⬆️ or ⬇️ to choose the force condition, and press Ⓜ️ to confirm and save it. The system will exit after 2 seconds.	
	L Light		
	n Normal		
	H Heavy		
SH Set Height	Original ^{①②}	Use ⬆️ or ⬇️ to choose the type of height after entering, and press Ⓜ️ to confirm and enter corresponding setting interface.	The interface displays last original height setting after entering. Use ⬆️ or ⬇️ to adjust the setting, and press Ⓜ️ to confirm and save it.
	L Low ^{①③}		The interface displays last lowest limit setting after entering. Use ⬆️ or ⬇️ to adjust the setting, and press Ⓜ️ to confirm and save it.
	H High ^{①③}		The interface displays last highest limit setting after entering. Use ⬆️ or ⬇️ to adjust the setting, and press Ⓜ️ to confirm and save it.
dE Demo It displays Pw_ (PassWord) enter your password to continue later operating. (PassWord:11111) ^④	OFF Off	The interface displays last demo mode setting after entering. Use ⬆️ or ⬇️ to choose demo mode, and press Ⓜ️ to confirm and save it. The system switches to height display interface if you choose off. Otherwise, the system switches to demo mode interface. Press ⬆️ to start-up and press ⬇️ to stop in demo mode.	
	S1 2min On,18min Off		
	S2 4min / cycle		
	S3 6min / cycle		
	S4 10min / cycle		

Note:

① Adjustment resolution is 1cm or 0.5inch.

- ② Original height refers to the position after reset, it can be adjusted between -20cm and +20cm (or -8inch and +8inch).
- ③ The highest limit set shall be 20cm or 8inch larger than lowest limit.
- ④ Password is five  when using WN18H45 handle.

5. Protection and Warning

A. Block protection: when it displays “E02”, it alarms when desktop in vibration, collision and tilt, auto-clear the alarm after rebounding; or press any key to clear the alarm during rebounding. You should check and ensure that the desk won’t operate in large amplitude vibration, barrier or tilt condition, then try to run again.

B. Overheat protection: when it displays “Hot”, this protection may be launched after running for a long time, you should wait for at least 18 minutes in order to use it again.

C. Motor fault protection: when it displays “E10”, you should check and ensure that the connection between motor and controller is reliable, then power it off and power it on again or press reset to clear it.

D. Overload protection: when it displays “E20”, you should remove some objects on the desktop when it occurs during the rise phase; or if it occurs during the decline phase, power it off and power it on again or press reset to clear it.

E. Undervoltage protection: when it displays “E31”, it alarms when the supply voltage is lower than limit value, you should power it off and power it on again to clear it. Otherwise, it can be auto-cleared after voltage goes to set value.



F. Overvoltage protection: when it displays “E32”, it alarms when the supply voltage is higher than limit value, you should power it off and power it on again to clear it. Otherwise, it can be auto-cleared after voltage goes to set value.

G. Out-of-step protection^①: when it displays “E60”, you should check and make sure the motors of each channel are identical and their connection to controller is reliable, then press reset to clear it.

Note:

- ① Only multi-motor system has out-of-step protection.

6. Stroke Reset

In the condition of “E10, E20 and E60^①” or basic position mode, long press  3 seconds, loosen it until it shows , the desk runs to the bottom and rebounds to certain height, reset finishes and shows lowest position height.

Note:

- ① Only multi-motor system has this condition.