

TWO MOTOR STANDING DESK

USER MANUAL



Universal version

Please learn this manual carefully before installation

I. Matters needing attention

1. Safety warning

- > Improper use of this product may cause personal safety
- > Before using the table, check the environment around the table. If the body or object is trapped in a stationary obstacle and the table's range of motion, it may be pressed
- > When operating the desk, make sure that the power cord is long enough. If the monitor, computer, speakers, and anything with a cord are not long enough, they may be pulled off during the movement of the desk, causing items to fall and damage
- > Please provide this manual to any users, installers and technicians who operate the product

2. Using

- > This height-adjustable table contains an electric motor and is only suitable for dry work areas; because the height of the table can be adjusted, it is convenient for individuals to set the most ergonomic height; this product cannot be used in high humidity or humid environments
- > Do not move forcibly, put down the table frame, do not sit or stand on the table frame, to avoid potential safety hazards
- > Children must use this product under adult supervision
- > Liability: In any case, except for the description in this operation manual, the manufacturer will not accept warranty claims and compensation liabilities caused by incorrect use

3. Setup and Installation

- > After the product is assembled, adjust the caster nut to make the table level. After fixing the position, check whether the wire is intact and whether there is any damage, etc. ,connect the table to the 110V ~ 220V socket, and use it normally
- > When placing this product, ensure that there is enough space and at the same time keep a safe distance from other furniture items. Do not place objects higher than 50cm (20 inches) under the table
- > After the table is assembled, when you want to move the table, do not lift the table alone when lifting the table.
- > Lifting the table alone will cause damage to the connecting parts and the fasteners of the table top. Grasp the table legs and move them slowly

4. Warranty terms

- > The supplier provides 36 months free warranty service for the product from the date of delivery (motor warranty is 20000 times)
- > During the warranty period, if the returned product has quality defects after inspection, the supplier will repair or replace it for free
- > The following scope does not belong to the free service scope:
Exceeding the warranty period, failing to use, maintain and store the product in accordance with the requirements of the product instructions, causing damage; Users disassembling and modifying without permission, using controllers and hand controllers not provided by the supplier, or damage caused by force majeure
- > In addition, all product repairs are sent to the supplier's factory for repair
- > This product is not equipped with a panel, customized samples do not use this manual

II. Tool & Parts Diagram

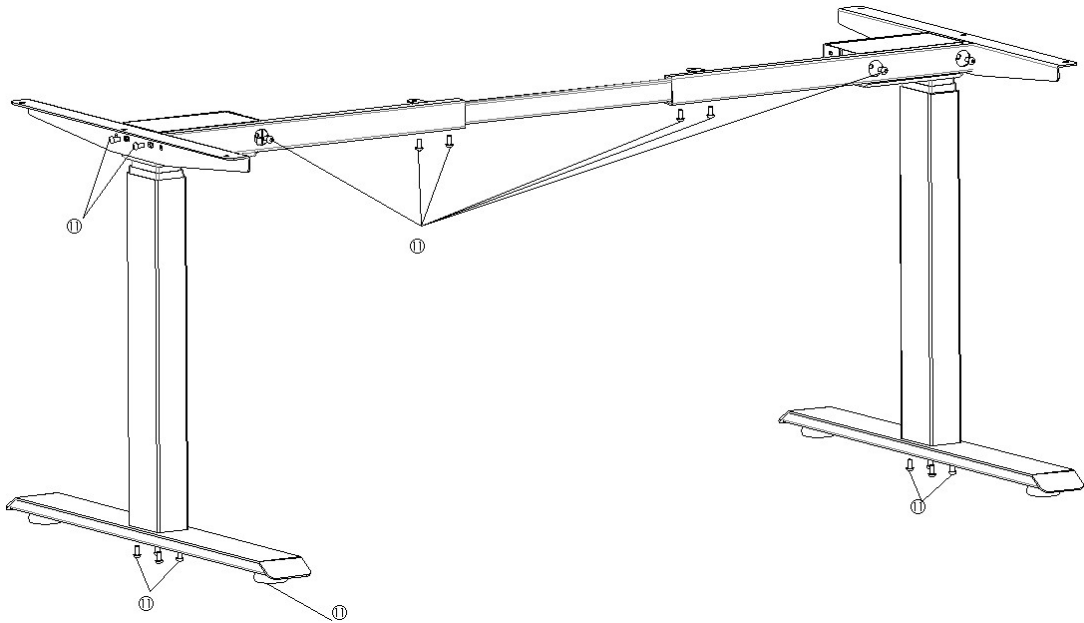

- ① Column*2 ② Foot*2 ③ Frame*2 ④ Side board*2 ⑤ Connecting rod*2

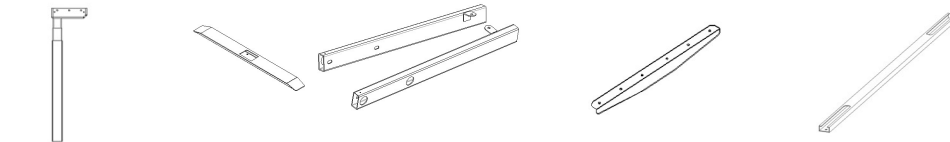

- ⑥ Controller*1 ⑦ Handset*1 ⑧ Power cable*1 ⑨ Allen wrench*1 ⑩ Casters*4



- ⑪ M6×12*21 ⑫ ST5×20*13 ⑬ Cushion washers*8 ⑭ Line snaps*3



III. Assembly instructions

> Check and make sure that all parts meet the above list. As shown in the figure below, fit the column (①) tightly to the frame (③), tighten it with screws (⑪)

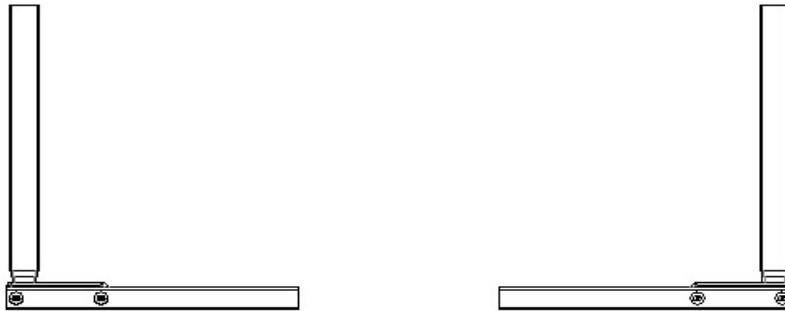

> Place the foot (②) on the column (①), tighten it with screws (⑪), screw the casters (⑩) on the foot (②)

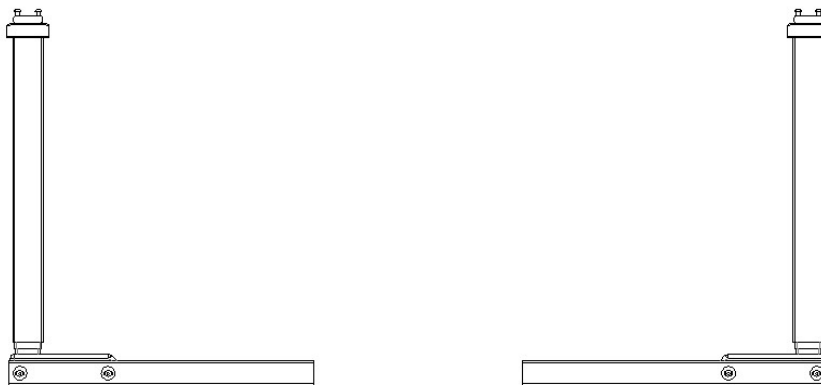

> Place the connecting rod (⑤) inside the frame (③), stretch the board to the right distance, tighten it with screws (⑪)

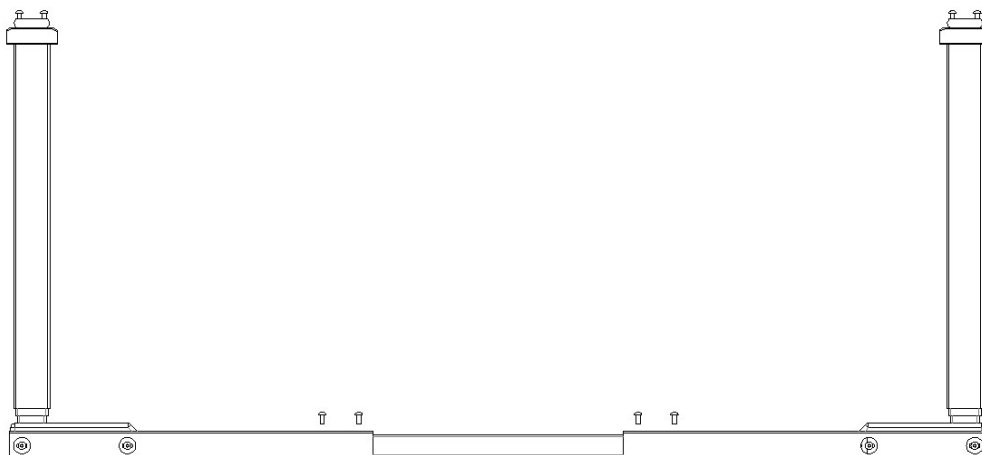

> Turn the table frame over when all screws are tightened, place the side board (④) on the frame (③), tighten it with screws (⑪), Install the Cushion washers (⑬) in the hole of the side board (④)

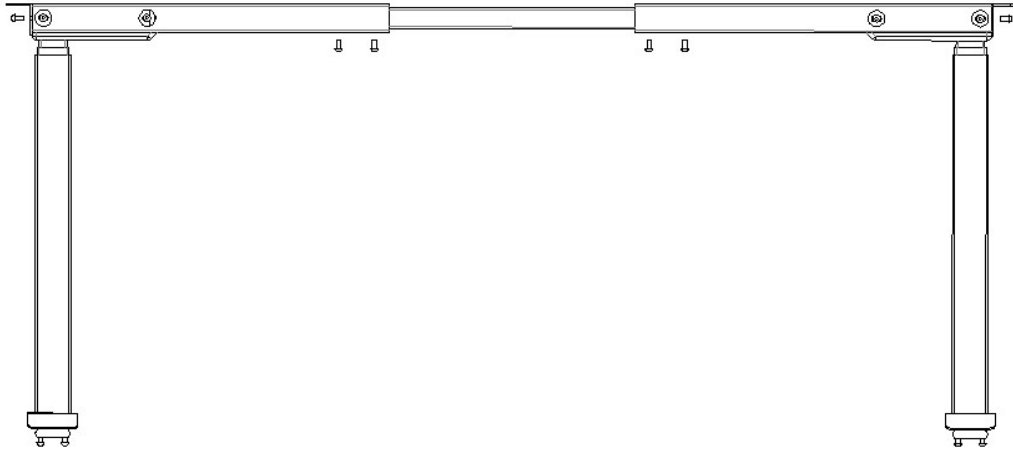

> Place the table stand on the panel, adjust to position, tighten it with screws (⑫). Place the controller (⑥) and Handset (⑦) in the position shown below, tighten it with screws (⑫)

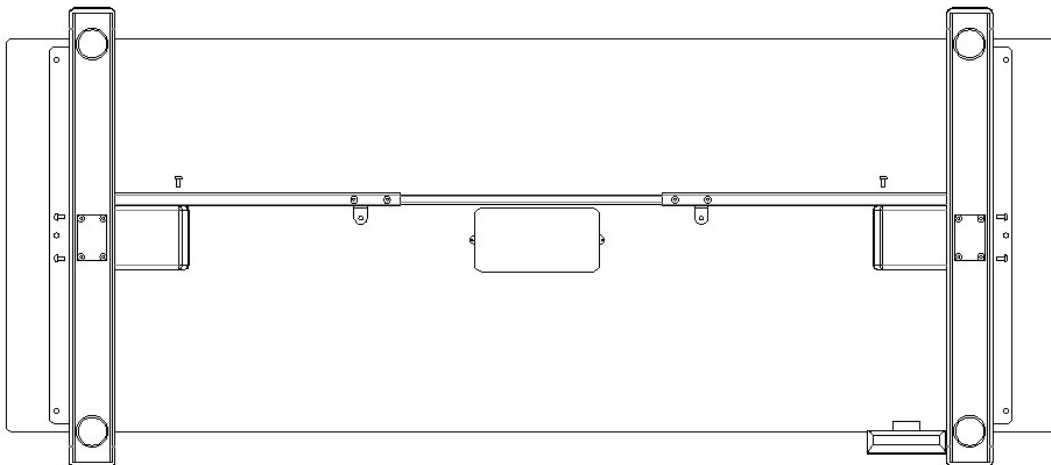

> Connect Power cable as shown below

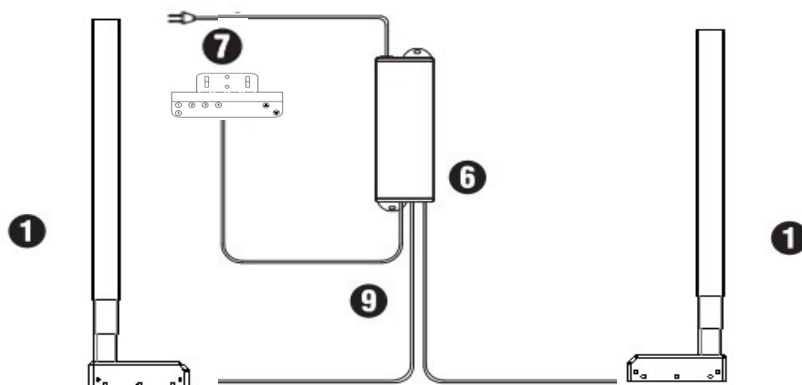

IV. Troubleshooting

1. Reset instructions

The newly installed desk (showing E10) needs to be reset after re-plugging in the connector, if there is an error message on the hand controller, there is no response when trying to raise or lower,

unplug the power cord;

reinsert the power cord;

press and hold the down button of the hand controller until the post reaches its lowest point and the reset mark appears, releases the lower button, the hand controller will display the height, and your standing desk will be used

2. Common troubleshooting

Resistance protection: display "E02", the desktop will vibrate, be impacted or the desktop is tilted during the exercise, and the alarm will be stopped immediately, and the reverse motion will be automatically released after the set distance, or press any key to stop and release during the reverse operation.

It should be checked and ensured that the table will not vibrate greatly, hit obstacles or tilt during operation.

Overheating protection: display "Hot", continuous long-term operation may activate this protection, you should re-power on or wait at least 18 minutes before using it.

Motor abnormal protection: display "E10", power off, recheck and make sure the connection between the motor and the controller is reliable, and then power on again

Overload protection: display "E20", this alarm appears when running upwards, you should remove some heavy objects on the table before running; if this alarm appears when running downwards, you should cut off the power, remove some heavy objects on the table, and then restart

Power-on

Undervoltage protection: display "E31", power off, recheck and make sure the connection between the power supply and the controller is reliable, and then power on again

Overvoltage protection: display "E32", power off, recheck and make sure the connection between the power supply and the controller is reliable, and then power on again

3. Safety reminder

When power is cut off or the power cord is unplugged, manual reset is required (please refer to the reset instructions above)

The design work system of this product is 10% (2 minutes of continuous work, 18 minutes of rest)

Children need to use this product reasonably under the supervision and company of an adult

Do not open any parts: columns, controllers, hand controls, to prevent damage to the product and electric shock, etc.

Keep all electrical parts away from the liquid