

Product e-catalog



CONTENTS

1 / PRODUCT SERIES

2 / ACCESSORIES

3 / ABOUT US

1

PROCU DT SERIES



Single leg desk series

Standard with up&down key hand control
Round desktop is the best match
Optional removable casters, not limited by space
Simplicity

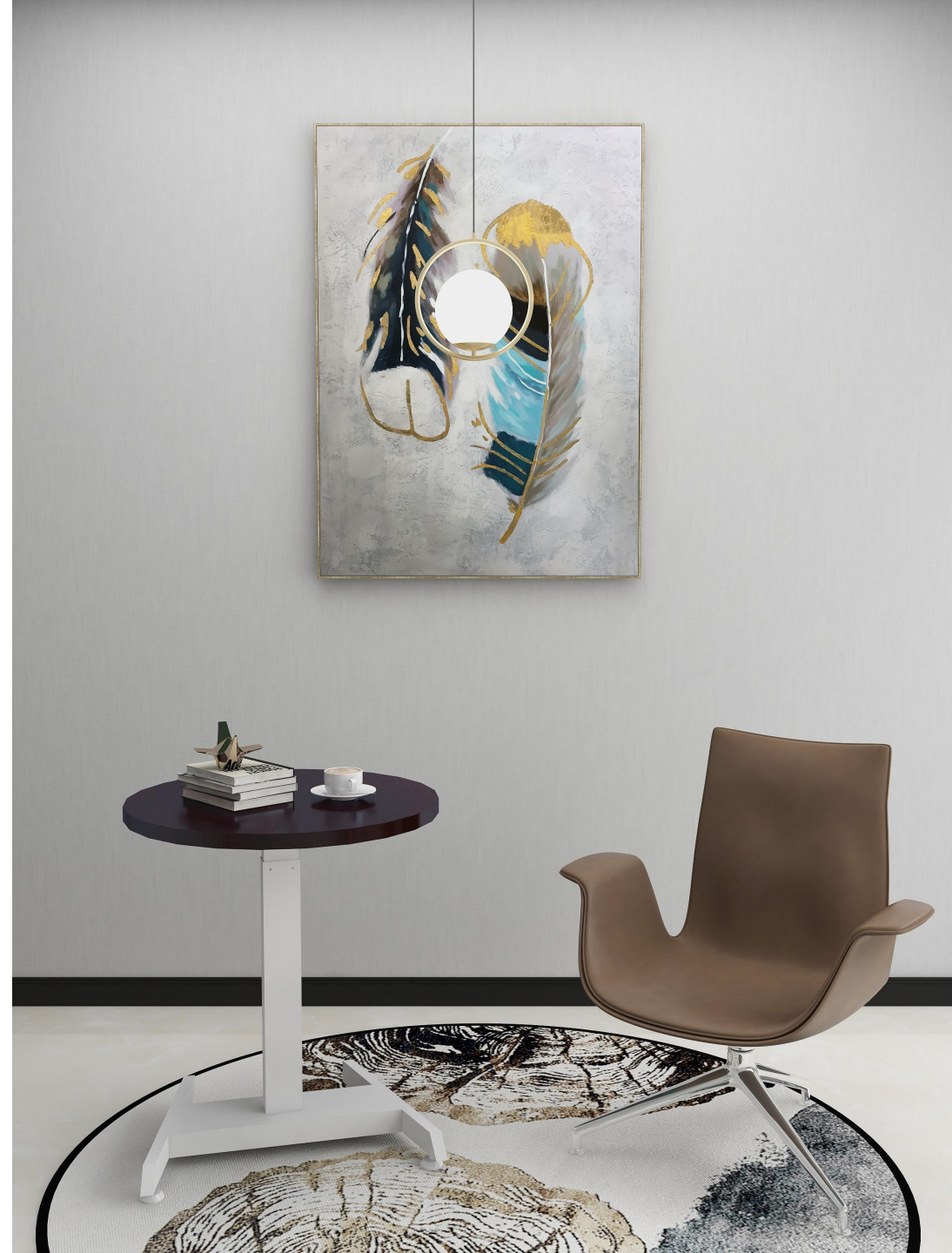

Load : 600N
Speed : 32mm/s

Tube L : 80*50*T1.5mm

Tube M : 75*45*T1.5mm

Tube S : 70*40*T1.5mm

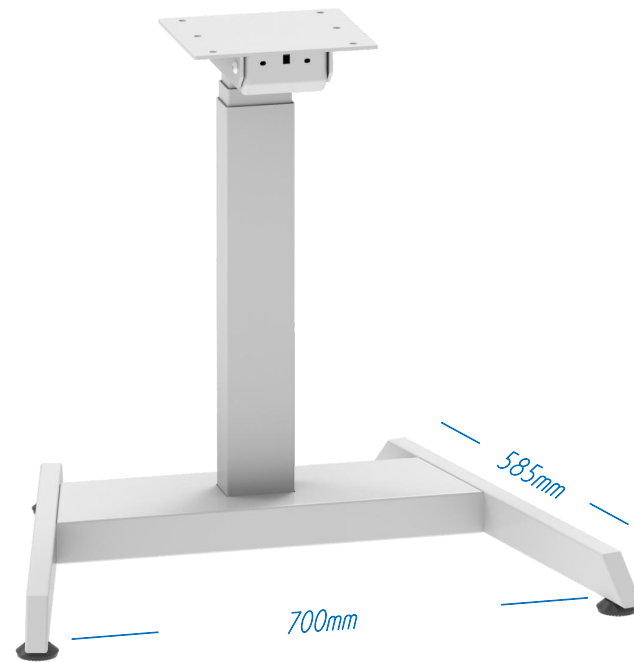

Height: 600—1250mm

Material: Metal Steel Frame



ZK-J3-1

Certification : UL / CE / BIFMA / FCC / RoSH / ISO9001, etc.

G.W.: 18kg N.W.: 16.5kg
Outer: Five-layer double corrugated
Inner: Pearl cotton (EPE)
1pc/ctn

20',40',40'HC: 680/1390/1600 pcs (Without tray)

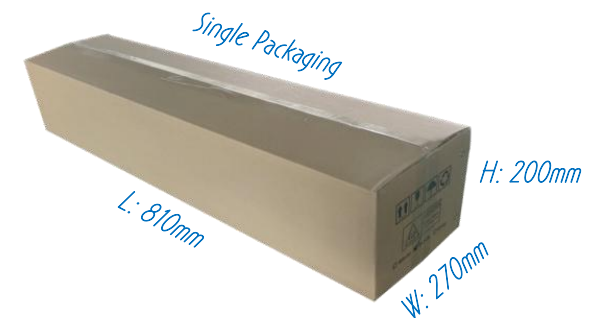

Note: For reference only, actual subject to inquiry

TV frame

Standard with 4 keys hand control and Wireless remote control
Meeting rooms, living rooms and bedrooms are the main use scenarios
Concealed cabinets allow for better space utilization



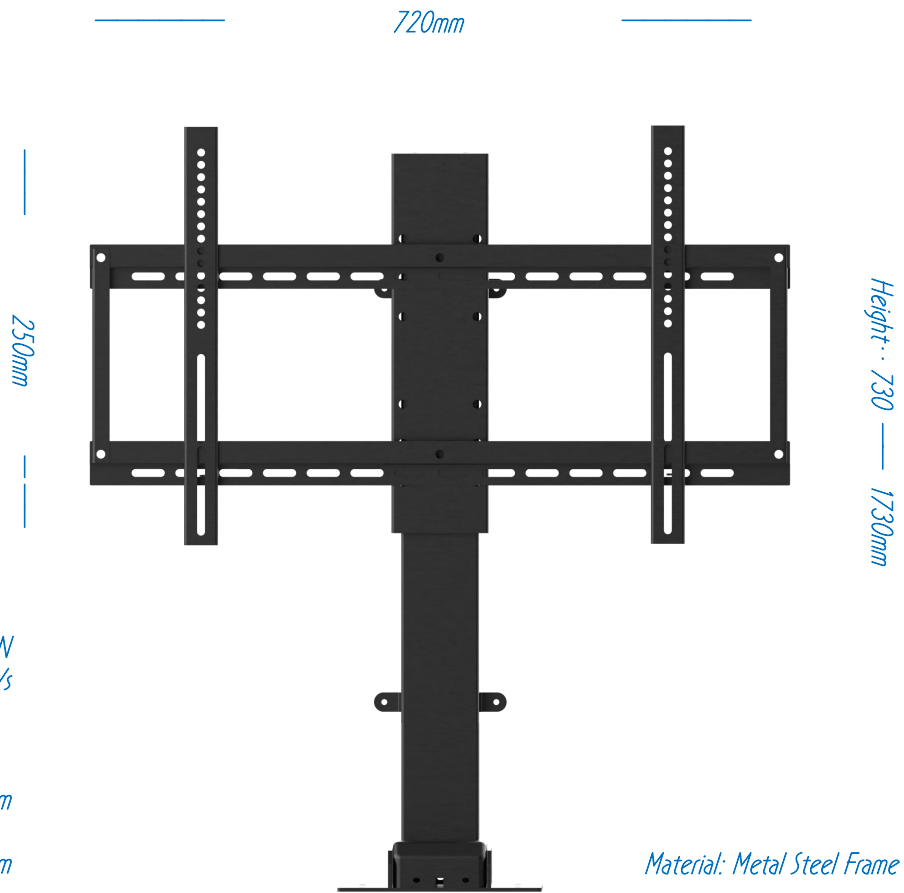

Load : 400N
Speed : 32mm/s

Tube L : 80*50*T1.5mm

Tube M : 75*45*T1.5mm

Tube S : 70*40*T1.5mm

Material: Metal Steel Frame



ZK-J3-TV
 Certification : UL / CE / BIFMA / FCC / RoSH / ISO9001, etc.
 G.W.: 18kg N.W.: 16.5kg
 Outer: Five-layer double corrugated
 Inner: Pearl cotton (EPE)
 1pc/ctn
 20', 40', 40' HC: 680/1390/1600 pcs (Without tray)

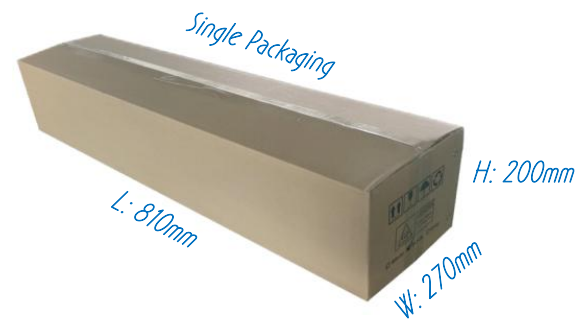

Note: For reference only, actual subject to inquiry



2 legs 2 stages series

Standard with 4 keys hand control
Meet the majority of people and scenarios
Extensive customized solutions
versatile



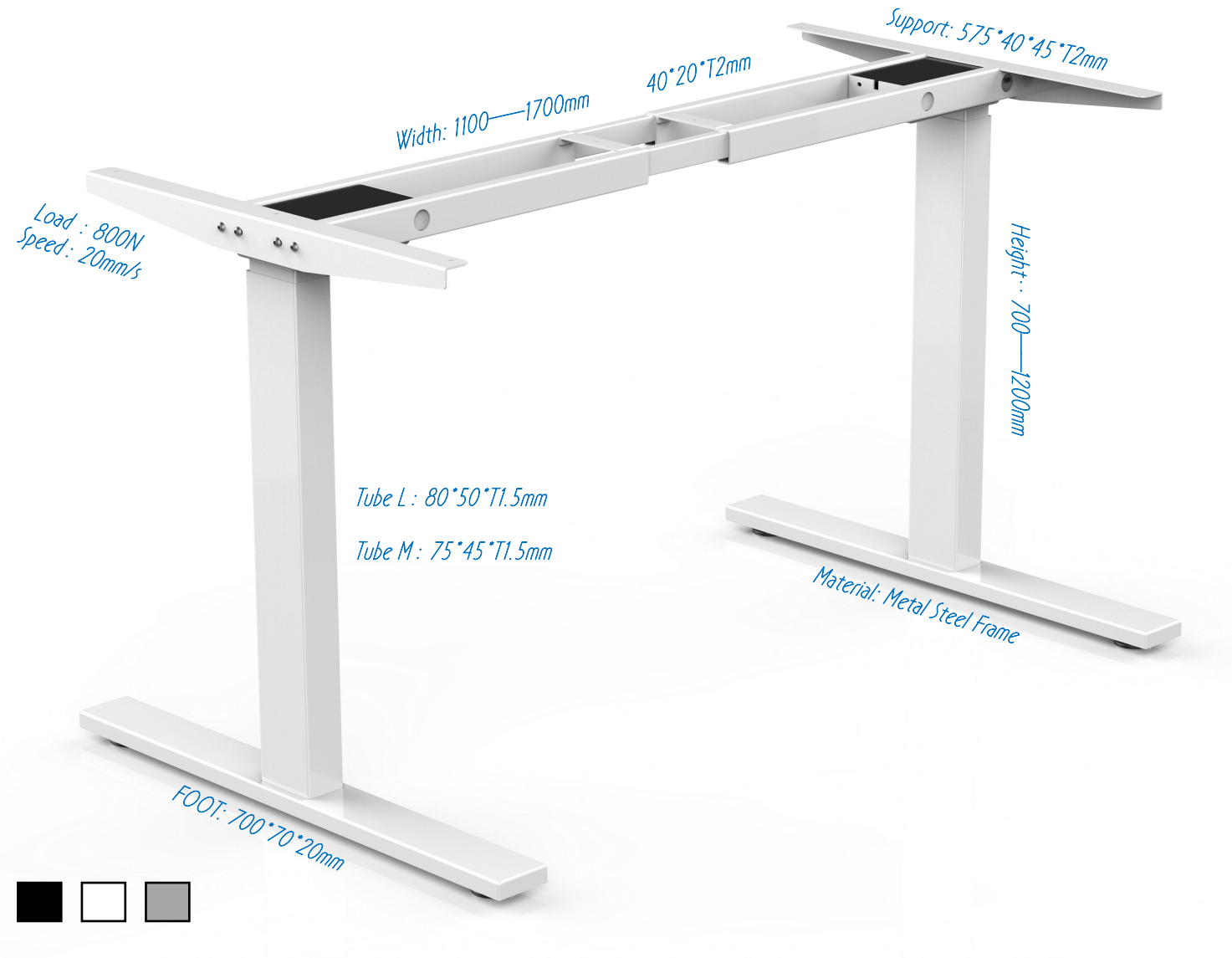

ZK-J2-2-A

Certification : UL / CE / BIFMA / FCC / RoSH / ISO9001, etc.

G.W.: 26kg N.W.: 24.5kg
 Outer: Five-layer double corrugated
 Inner: Pearl cotton (EPE)
 1pc/ctn

20',40',40'HC: 570/1170/1310 pcs (Without tray)

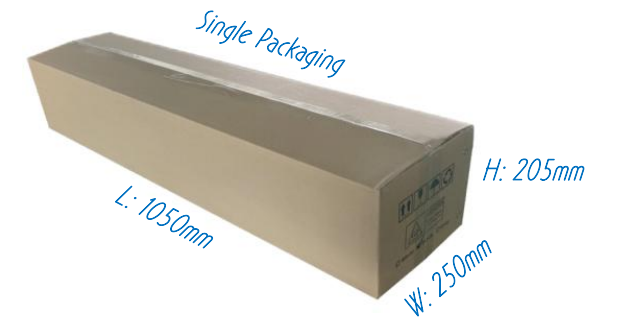

Note: For reference only, actual subject to inquiry

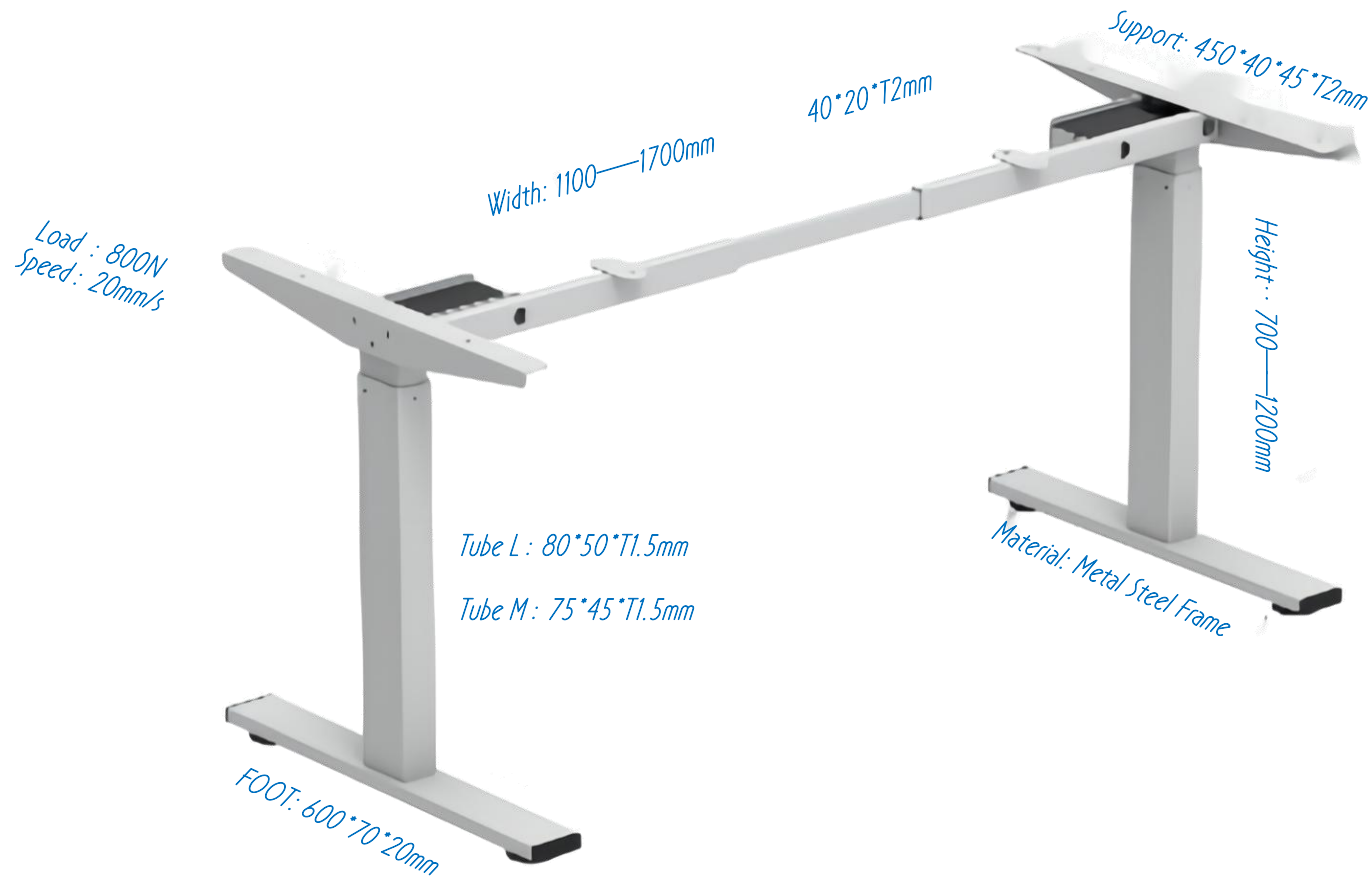

ZK-J2-2-A-5

Certification : UL / CE / BIFMA / FCC / RoSH / ISO9001, etc.

G.W.: 25kg N.W.: 23.5kg
Outer: Five-layer double corrugated
Inner: Pearl cotton (EPE)
1pc/ctn

20',40',40'HC: 570/1170/1310 pcs (Without tray)

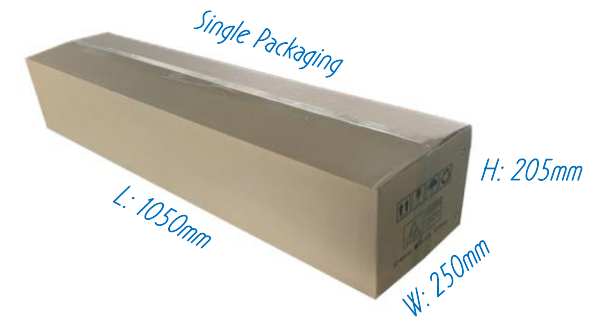

Note: For reference only, actual subject to inquiry

2 legs 2 stages series (single motor)

All-in-one controller system
Single beam telescopic structure
Cost-effective choice
Small scenes



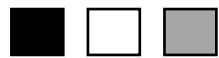
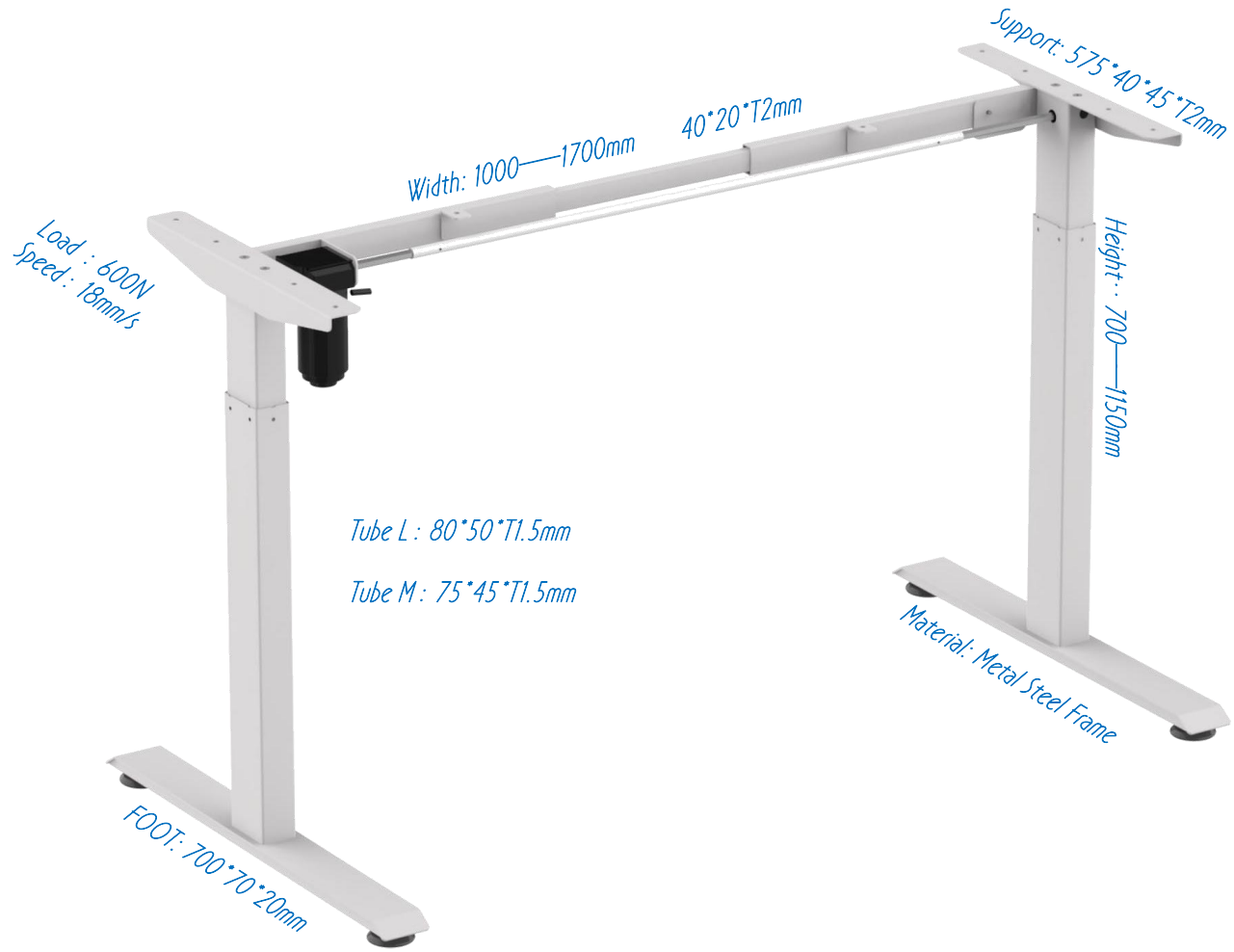

ZK-DI2

Certification : UL / CE / BIFMA / FCC / RoSH / ISO9001, etc.

G.W.: 23kg N.W.: 21kg

Outer: Five-layer double corrugated

Inner: Pearl cotton (EPE)

1pc/ctn

20',40',40'HC: 570/1170/1310 pcs (Without tray)

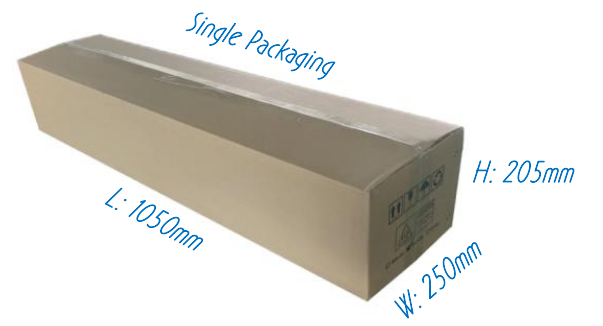

Note: For reference only, actual subject to inquiry



2 legs 3 stages series

Standard with 4 keys hand control
The best choice in standing desk
One of the most representative models



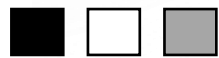
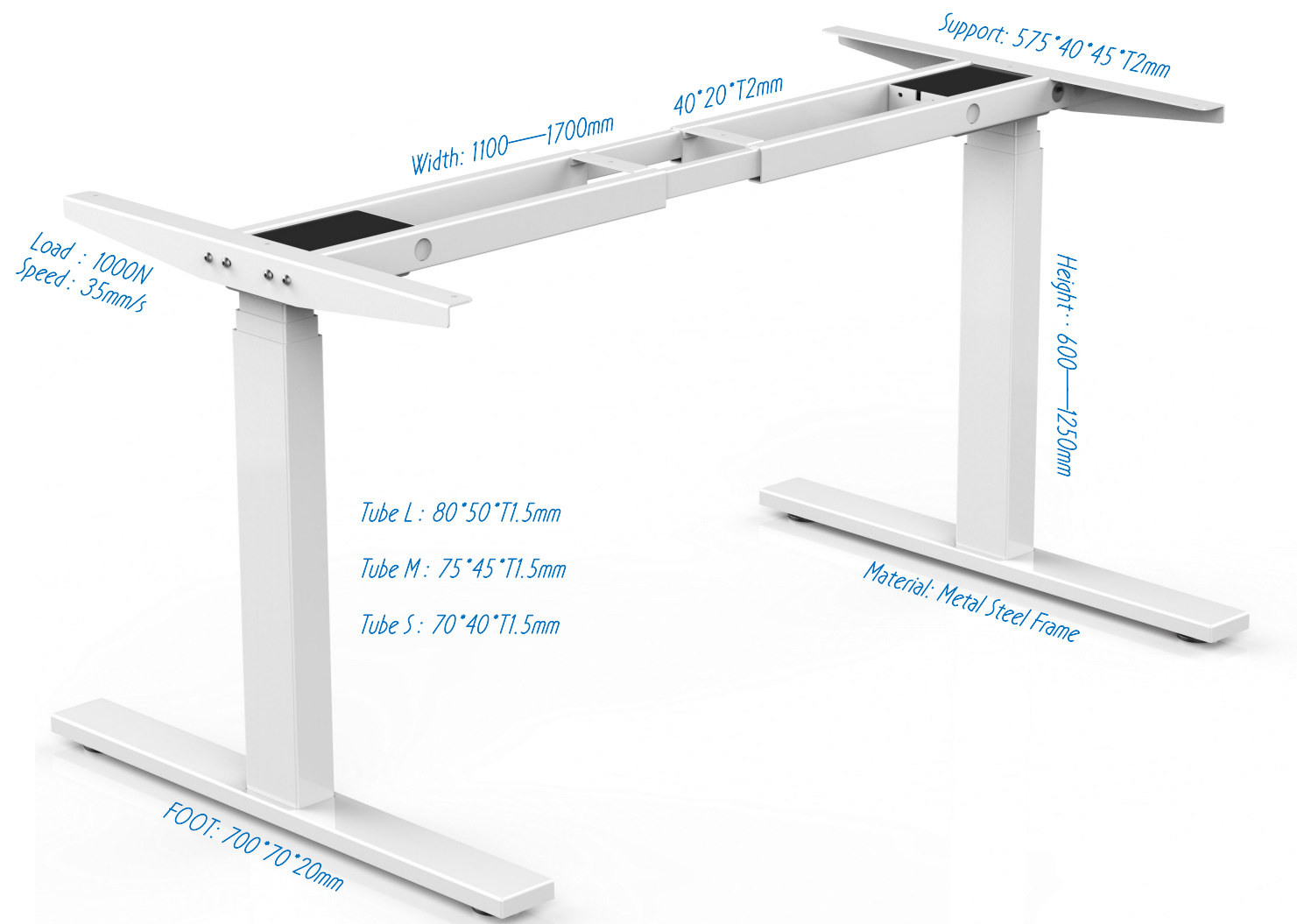

ZK-J3-2-A

Certification : UL / CE / BIFMA / FCC / RoSH / ISO9001, etc.

G.W.: 28kg N.W.: 26.5kg
Outer: Five-layer double corrugated
Inner: Pearl cotton (EPE)
1pc/ctn

20',40',40'HC: 570/1170/1310 pcs (Without tray)

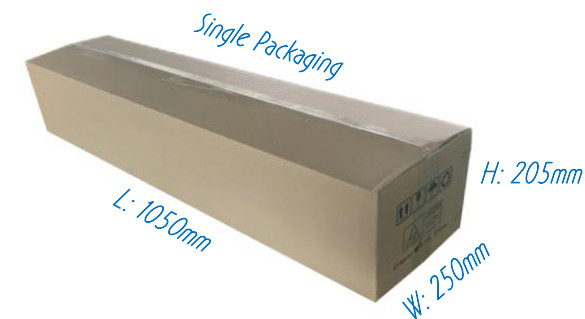

Note: For reference only, actual subject to inquiry

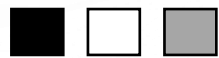

ZK-J3-2-B

Certification: UL / CE / BIFMA / FCC / RoSH / ISO9001, etc.

G.W.: 28kg N.W.: 26.5kg

Outer: Five-layer double corrugated

Inner: Pearl cotton (EPE)

1pc/ctn

20', 40', 40'HC: 570/1170/1310 pcs (Without tray)

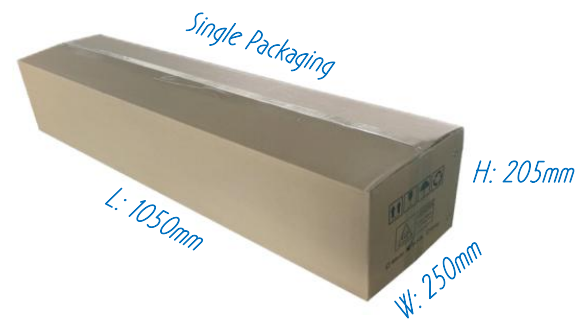

Note: For reference only, actual subject to inquiry



3 legs 3 stages series

Executive level
The best choice for independent offices
Elegant office system space
Meeting room



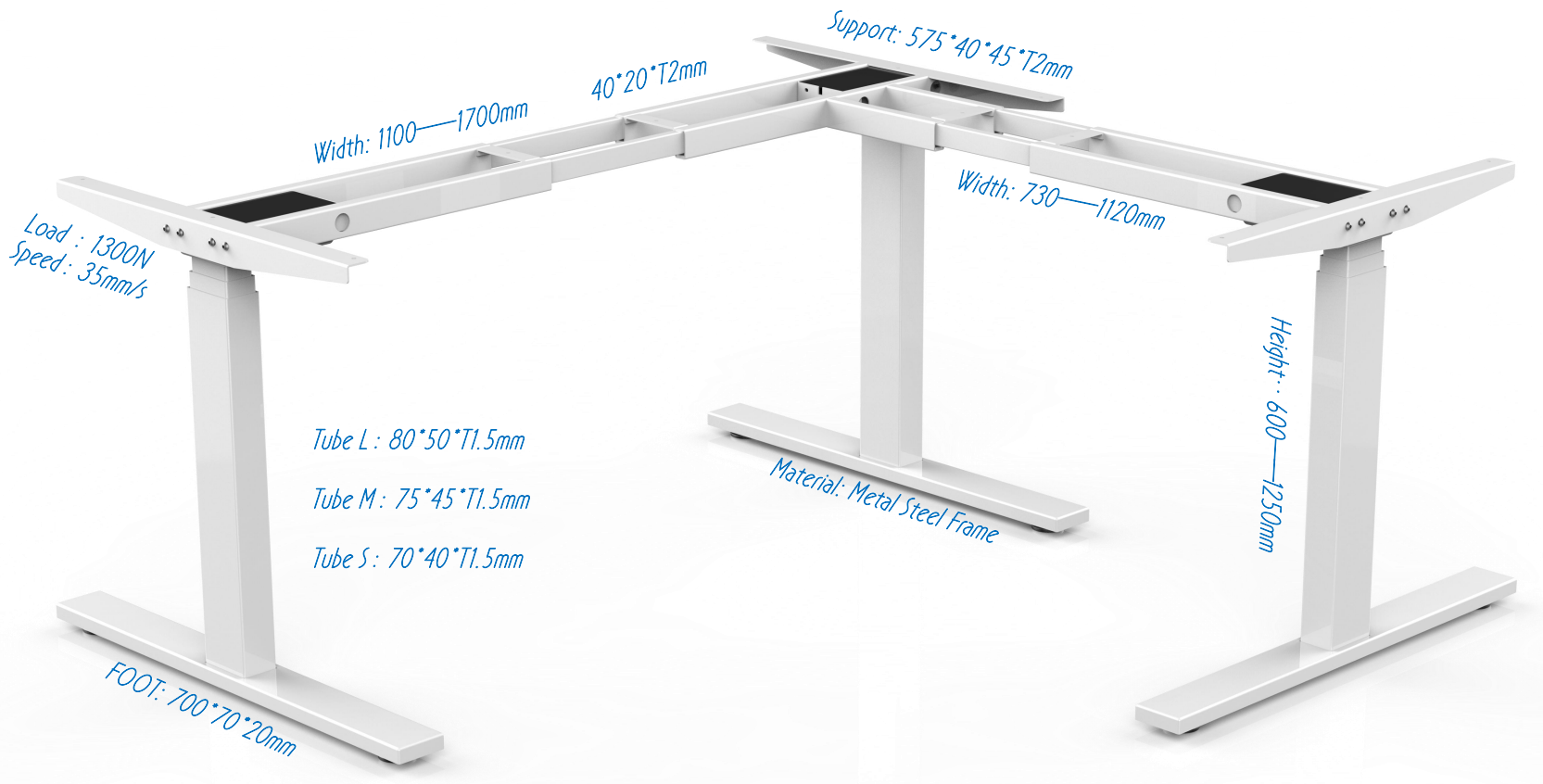

ZK-J3-3-90°

Certification: UL / CE / BIFMA / FCC / RoSH / ISO9001, etc.

G.W.: 48kg N.W.: 45.5kg
 Outer: Five-layer double corrugated
 Inner: Pearl cotton (EPE)
 1pc/ctn

20', 40', 40" HC: 435/910/1030 pcs (Without tray)

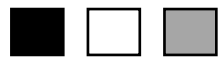
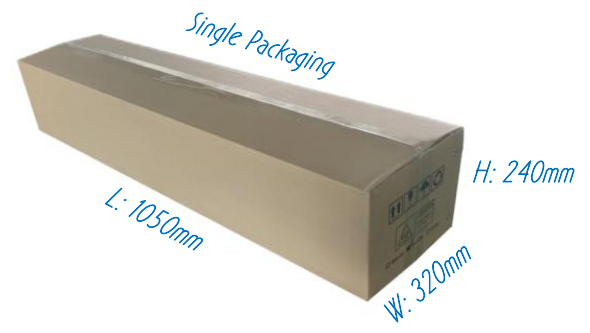

Note: For reference only, actual subject to inquiry

Support: 575*40*45*T2mm

450*40*45*T2mm

40*20*T2mm

Width: 1000—1700mm

Load: 1300N
Speed: 35mm/s

FOOT: 700*70*20mm

Material: Metal Steel Frame

Height: 600—1250mm

Tube L: 80*50*T1.5mm

Tube M: 75*45*T1.5mm

Tube S: 70*40*T1.5mm

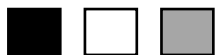

ZK-J3-3-120°

Certification: UL / CE / BIFMA / FCC / RoSH / ISO9001, etc.

G.W.: 46kg N.W.: 44kg
Outer: Five-layer double corrugated
Inner: Pearl cotton (EPE)
1pc/ctn

20', 40', 40' HC: 435/910/1030 pcs (Without tray)

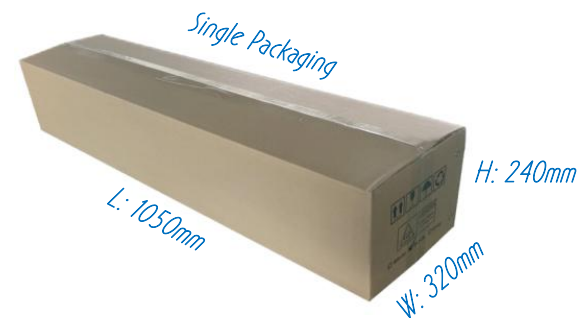

L: 1050mm

W: 320mm

H: 240mm

Note: For reference only, actual subject to inquiry

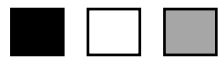
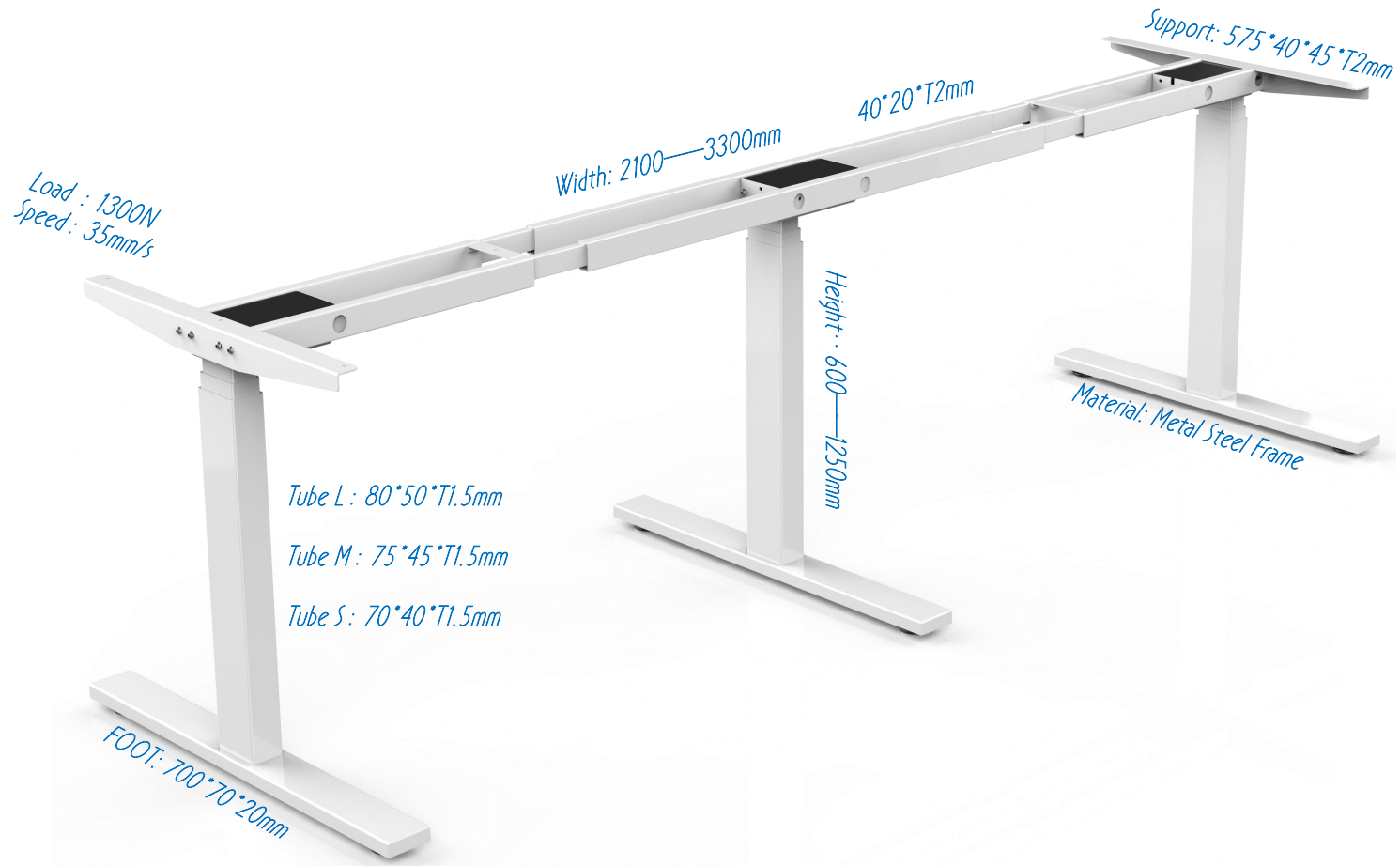

ZK-J3-3-180°

Certification: UL / CE / BIFMA / FCC / RoSH / ISO9001, etc.

G.W.: 46kg N.W.: 44kg
 Outer: Five-layer double corrugated
 Inner: Pearl cotton (EPE)
 1pc/ctn

20', 40', 40' HC: 435/910/1030 pcs (Without tray)

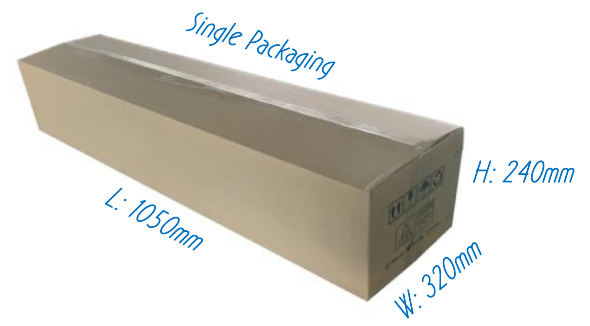

Note: For reference only, actual subject to inquiry



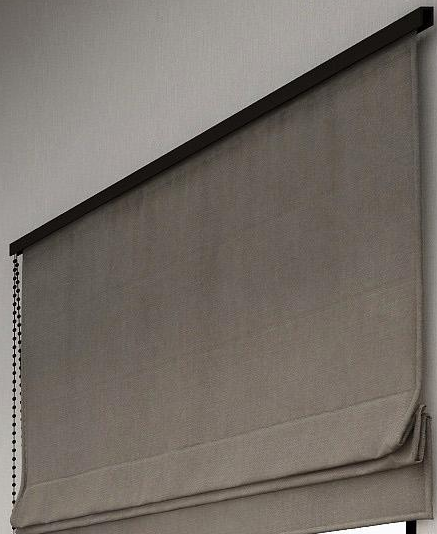

2 seats 3 stages series

Executive level
Embodiment of integrated office systems
Elegant office system space



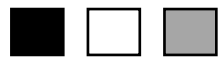

ZK-J3-4

Certification : UL / CE / BIFMA / FCC / RoSH / ISO9001, etc.

G.W.: 60kg N.W.: 55kg
Outer: Five-layer double corrugated
Inner: Pearl cotton (EPE)
1pc/ctn

20', 40', 40'HC: 285/585/655 pcs (Without tray)

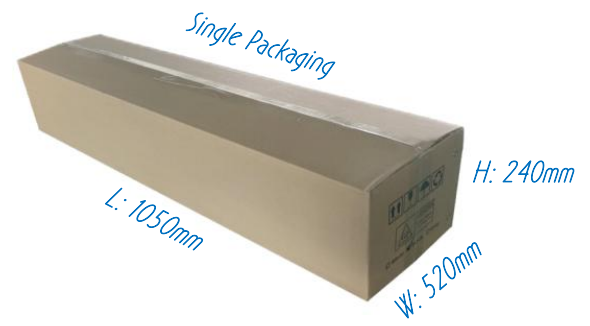

Note: For reference only, actual subject to inquiry

2

ACCESSORIES

COLUMNS

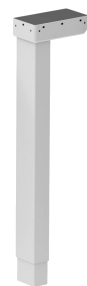

D2
80*50
75*45

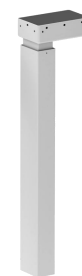

Z2
80*50
75*45

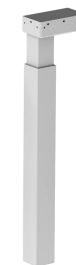

FZ2
70*70
60*60

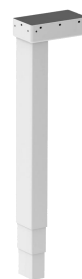

D3
80*50
75*45
70*40



Z3
80*50
75*45
70*40

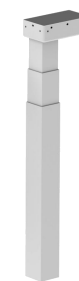

FZ3
70*70
65*65
60*60





Up/Down



Integrated



USB/Bluetooth



*Control Box
connect 2*



4 Memory



Other/Custom

Color



Material Choices



Particle Board



Density Board

Edge Choices



Standard Edge



Rounded Edge

OPTIONAL ACCESSORIES



Office/Gaming Chair



Anti-Fatigue Standing Mat



CPU Holder



Monitor Arm



Desk Light



Office Partition



Socket



Serpentine Tube

3

ABOUT US

Company Profile

Shaoxing Zhikang Drive Technology Co., Ltd. is an enterprise specializing in the research and development, production and sales of electric standing desk drive systems and products. Products are mainly used in office, home and other fields. The company has a professional R&D team and an excellent management team. The production process pursues the refinement of craftsmanship and quality, and organizes production in strict accordance with modern enterprise management standards; from product contract signing, material procurement, production and manufacturing to delivery and use, fully comply with the ISO9001 quality management system and refined management

CERTIFICATION

Certificate of Registration



The Governing Board of
QA International Certification Limited
Incorporated in Great Britain

Shaoxing Zhikang Driving Technology Co., Ltd.
160200, China

Business License Address:
Building 3, No. 8, Hang'er Road, Nanjing Industrial Concentration Zone, Nanjing Street,
Shaoxing, Zhejiang Province, P.R. China

Active Business Address to which this Certificate is assigned:
Building 3, No. 8, Hang'er Road, Nanjing Industrial Concentration Zone, Nanjing Street,
Shaoxing, Zhejiang Province, P.R. China



Approved Scope to which this Certificate refers:
The Manufacture of Every Model of Park Road Lifting Worktable.

Approved for on behalf of the Board:
 SCHEME MANAGER

Certificate Number: **736-001-2019** - Certificate Renewal Date: 2024 July 2019
Date of Issue: 2019-06-20 - The Certificate Expires: 2024-06-20

This Certificate of Registration is granted subject to the Regulations approved by the Board. The Regulations are available on the QA International website at: www.qainternational.com

The Board reserves the right to suspend or withdraw this certificate if the holder fails to comply with the Regulations.

Certificate of Conformity

Certificate Number: B-E19024957
EMC Directive 2014/53/EU

Beide

Holder: Shaoxing Zhikang Drive Technology Co Ltd
Address: No.8 Hang'er Road, Building 3, Nanjing Industrial Concentration Zone, Nanjing Street, Shaoxing City, Zhejiang Province, China.
Manufacturer: Same As Holder
Product: Electric Office Lifting Table
Model No.: ZK-D-2A, ZK-D-3A, ZK-D-3B, ZK-D-3C, ZK-D-3D, ZK-D-3E, ZK-D-3F, ZK-D-3G, ZK-D-3H, ZK-D-3I, ZK-D-3J, ZK-D-3K, ZK-D-3L, ZK-D-3M, ZK-D-3N, ZK-D-3O, ZK-D-3P, ZK-D-3Q, ZK-D-3R, ZK-D-3S, ZK-D-3T, ZK-D-3U, ZK-D-3V, ZK-D-3W, ZK-D-3X, ZK-D-3Y, ZK-D-3Z, ZK-D-4A, ZK-D-4B, ZK-D-4C, ZK-D-4D, ZK-D-4E, ZK-D-4F, ZK-D-4G, ZK-D-4H, ZK-D-4I, ZK-D-4J, ZK-D-4K, ZK-D-4L, ZK-D-4M, ZK-D-4N, ZK-D-4O, ZK-D-4P, ZK-D-4Q, ZK-D-4R, ZK-D-4S, ZK-D-4T, ZK-D-4U, ZK-D-4V, ZK-D-4W, ZK-D-4X, ZK-D-4Y, ZK-D-4Z, ZK-D-5A, ZK-D-5B, ZK-D-5C, ZK-D-5D, ZK-D-5E, ZK-D-5F, ZK-D-5G, ZK-D-5H, ZK-D-5I, ZK-D-5J, ZK-D-5K, ZK-D-5L, ZK-D-5M, ZK-D-5N, ZK-D-5O, ZK-D-5P, ZK-D-5Q, ZK-D-5R, ZK-D-5S, ZK-D-5T, ZK-D-5U, ZK-D-5V, ZK-D-5W, ZK-D-5X, ZK-D-5Y, ZK-D-5Z

Technical Data: 100V-240V/50/60Hz 230V

The sub-registered products have been tested by us with the following standards and found to be in compliance with the stated European Directive:
EN 61010-1:2017, EN 12171, EN 61010-2-2017, EN 61010-3:2017, EN 61010-3-2:2013

The test results apply to the particular sample tested and to the specific tests carried out. Technical Report and explanation are on file at the holder's premises.

This certificate applies specifically to the sample investigated and is not transferable to other lots. The CE markings as shown below can be affixed to the product after preparation of necessary technical documentation. Other relevant Directives have to be observed.

Beide (Shenzhen) Product Service Limited
China Rd, Bldg E, Phase 2, 1st Zone, Xixiang, Baoan Dist, Shenzhen, China
<http://www.beide.com> E-mail: china@beide.com

Certificate of Conformity

Certificate Number: B-519024958
Low Voltage Directive 2014/35/EU

Beide



Holder: Shaoxing Zhikang Drive Technology Co Ltd
Address: No.8 Hang'er Road, Building 3, Nanjing Industrial Concentration Zone, Nanjing Street, Shaoxing City, Zhejiang Province, China.
Manufacturer: Same As Holder
Product: Electric Office Lifting Table
Model No.: ZK-D-2A, ZK-D-3A, ZK-D-3B, ZK-D-3C, ZK-D-3D, ZK-D-3E, ZK-D-3F, ZK-D-3G, ZK-D-3H, ZK-D-3I, ZK-D-3J, ZK-D-3K, ZK-D-3L, ZK-D-3M, ZK-D-3N, ZK-D-3O, ZK-D-3P, ZK-D-3Q, ZK-D-3R, ZK-D-3S, ZK-D-3T, ZK-D-3U, ZK-D-3V, ZK-D-3W, ZK-D-3X, ZK-D-3Y, ZK-D-3Z, ZK-D-4A, ZK-D-4B, ZK-D-4C, ZK-D-4D, ZK-D-4E, ZK-D-4F, ZK-D-4G, ZK-D-4H, ZK-D-4I, ZK-D-4J, ZK-D-4K, ZK-D-4L, ZK-D-4M, ZK-D-4N, ZK-D-4O, ZK-D-4P, ZK-D-4Q, ZK-D-4R, ZK-D-4S, ZK-D-4T, ZK-D-4U, ZK-D-4V, ZK-D-4W, ZK-D-4X, ZK-D-4Y, ZK-D-4Z, ZK-D-5A, ZK-D-5B, ZK-D-5C, ZK-D-5D, ZK-D-5E, ZK-D-5F, ZK-D-5G, ZK-D-5H, ZK-D-5I, ZK-D-5J, ZK-D-5K, ZK-D-5L, ZK-D-5M, ZK-D-5N, ZK-D-5O, ZK-D-5P, ZK-D-5Q, ZK-D-5R, ZK-D-5S, ZK-D-5T, ZK-D-5U, ZK-D-5V, ZK-D-5W, ZK-D-5X, ZK-D-5Y, ZK-D-5Z

Technical Data: 100V-240V/50/60Hz 230V

The sub-registered products have been tested by us with the following standards and found to be in compliance with the stated European Directive:
EN 60204-1:2000+A1:2000

The test results apply to the particular sample tested and to the specific tests carried out. Technical Report and explanation are on file at the holder's premises.

This certificate applies specifically to the sample investigated and is not transferable to other lots. The CE markings as shown below can be affixed to the product after preparation of necessary technical documentation. Other relevant Directives have to be observed.

Beide (Shenzhen) Product Service Limited
#1 Bldg E, Phase 2, 1st Zone, Xixiang, Baoan Dist, Shenzhen, China
<http://www.beide.com> E-mail: china@beide.com

Certificate of Conformity

Certificate Number: B-519024959

Beide



Holder: Shaoxing Zhikang Drive Technology Co Ltd
Address: No.8 Hang'er Road, Building 3, Nanjing Industrial Concentration Zone, Nanjing Street, Shaoxing City, Zhejiang Province, China.
Manufacturer: Same As Holder
Product: Electric Office Lifting Table
Model No.: ZK-D-2A, ZK-D-3A, ZK-D-3B, ZK-D-3C, ZK-D-3D, ZK-D-3E, ZK-D-3F, ZK-D-3G, ZK-D-3H, ZK-D-3I, ZK-D-3J, ZK-D-3K, ZK-D-3L, ZK-D-3M, ZK-D-3N, ZK-D-3O, ZK-D-3P, ZK-D-3Q, ZK-D-3R, ZK-D-3S, ZK-D-3T, ZK-D-3U, ZK-D-3V, ZK-D-3W, ZK-D-3X, ZK-D-3Y, ZK-D-3Z, ZK-D-4A, ZK-D-4B, ZK-D-4C, ZK-D-4D, ZK-D-4E, ZK-D-4F, ZK-D-4G, ZK-D-4H, ZK-D-4I, ZK-D-4J, ZK-D-4K, ZK-D-4L, ZK-D-4M, ZK-D-4N, ZK-D-4O, ZK-D-4P, ZK-D-4Q, ZK-D-4R, ZK-D-4S, ZK-D-4T, ZK-D-4U, ZK-D-4V, ZK-D-4W, ZK-D-4X, ZK-D-4Y, ZK-D-4Z, ZK-D-5A, ZK-D-5B, ZK-D-5C, ZK-D-5D, ZK-D-5E, ZK-D-5F, ZK-D-5G, ZK-D-5H, ZK-D-5I, ZK-D-5J, ZK-D-5K, ZK-D-5L, ZK-D-5M, ZK-D-5N, ZK-D-5O, ZK-D-5P, ZK-D-5Q, ZK-D-5R, ZK-D-5S, ZK-D-5T, ZK-D-5U, ZK-D-5V, ZK-D-5W, ZK-D-5X, ZK-D-5Y, ZK-D-5Z

Technical Data: 100V-240V/50/60Hz 230V

The sub-registered products have been tested by us with the following standards and found to be in compliance with the stated European Directive:
EN 60204-1:2000, EN 62777:2014+A1:2019

The test results apply to the particular sample tested and to the specific tests carried out. Technical Report and explanation are on file at the holder's premises.

This certificate applies specifically to the sample investigated and is not transferable to other lots. The CE markings as shown below can be affixed to the product after preparation of necessary technical documentation. Other relevant Directives have to be observed.

Beide (Shenzhen) Product Service Limited
#1 Bldg E, Phase 2, 1st Zone, Xixiang, Baoan Dist, Shenzhen, China
<http://www.beide.com> E-mail: china@beide.com

SGS

Test Report No. **AKL2000018807** Date: **JUL 06, 2020** Page 1 of 4

SHAOXING ZHIKANG DRIVE TECHNOLOGY CO., LTD
160200, CHINA
No. 8 Hang'er Road, Building 3, Nanjing Industrial Concentration Zone, Nanjing Street, Shaoxing City, Zhejiang Province, China

The following samples were tested and identified as part of the client. SGS is not responsible for the collection, storage and handling of the sample and information on the sample of the manufacturer. Results apply to the sample as received.

Client Information
Client Name: SHAOXING ZHIKANG DRIVE TECHNOLOGY CO., LTD
Client Address: No. 8 Hang'er Road, Building 3, Nanjing Industrial Concentration Zone, Nanjing Street, Shaoxing City, Zhejiang Province, China

Sample Information
Sample Name: ELECTRIC OFFICE LIFTING TABLE
Sample No.: ZK-D-2A, ZK-D-3A, ZK-D-3B, ZK-D-3C, ZK-D-3D, ZK-D-3E, ZK-D-3F, ZK-D-3G, ZK-D-3H, ZK-D-3I, ZK-D-3J, ZK-D-3K, ZK-D-3L, ZK-D-3M, ZK-D-3N, ZK-D-3O, ZK-D-3P, ZK-D-3Q, ZK-D-3R, ZK-D-3S, ZK-D-3T, ZK-D-3U, ZK-D-3V, ZK-D-3W, ZK-D-3X, ZK-D-3Y, ZK-D-3Z, ZK-D-4A, ZK-D-4B, ZK-D-4C, ZK-D-4D, ZK-D-4E, ZK-D-4F, ZK-D-4G, ZK-D-4H, ZK-D-4I, ZK-D-4J, ZK-D-4K, ZK-D-4L, ZK-D-4M, ZK-D-4N, ZK-D-4O, ZK-D-4P, ZK-D-4Q, ZK-D-4R, ZK-D-4S, ZK-D-4T, ZK-D-4U, ZK-D-4V, ZK-D-4W, ZK-D-4X, ZK-D-4Y, ZK-D-4Z, ZK-D-5A, ZK-D-5B, ZK-D-5C, ZK-D-5D, ZK-D-5E, ZK-D-5F, ZK-D-5G, ZK-D-5H, ZK-D-5I, ZK-D-5J, ZK-D-5K, ZK-D-5L, ZK-D-5M, ZK-D-5N, ZK-D-5O, ZK-D-5P, ZK-D-5Q, ZK-D-5R, ZK-D-5S, ZK-D-5T, ZK-D-5U, ZK-D-5V, ZK-D-5W, ZK-D-5X, ZK-D-5Y, ZK-D-5Z

Test Results
Test Name: EMC
Result: PASS

Reported by: [Signature]
Approved by: [Signature]

BCTC

EMC Test Report No. **20200704001** Date: **2020-07-04**

Address: C17, East of 8 Building, Zhengzhou Institute of Aeronautical Education, Zhengzhou, Henan, China

Product Name: Electric Office Height Adjustable Desk

Model No.: ZK-D-2A, ZK-D-3A, ZK-D-3B, ZK-D-3C, ZK-D-3D, ZK-D-3E, ZK-D-3F, ZK-D-3G, ZK-D-3H, ZK-D-3I, ZK-D-3J, ZK-D-3K, ZK-D-3L, ZK-D-3M, ZK-D-3N, ZK-D-3O, ZK-D-3P, ZK-D-3Q, ZK-D-3R, ZK-D-3S, ZK-D-3T, ZK-D-3U, ZK-D-3V, ZK-D-3W, ZK-D-3X, ZK-D-3Y, ZK-D-3Z, ZK-D-4A, ZK-D-4B, ZK-D-4C, ZK-D-4D, ZK-D-4E, ZK-D-4F, ZK-D-4G, ZK-D-4H, ZK-D-4I, ZK-D-4J, ZK-D-4K, ZK-D-4L, ZK-D-4M, ZK-D-4N, ZK-D-4O, ZK-D-4P, ZK-D-4Q, ZK-D-4R, ZK-D-4S, ZK-D-4T, ZK-D-4U, ZK-D-4V, ZK-D-4W, ZK-D-4X, ZK-D-4Y, ZK-D-4Z, ZK-D-5A, ZK-D-5B, ZK-D-5C, ZK-D-5D, ZK-D-5E, ZK-D-5F, ZK-D-5G, ZK-D-5H, ZK-D-5I, ZK-D-5J, ZK-D-5K, ZK-D-5L, ZK-D-5M, ZK-D-5N, ZK-D-5O, ZK-D-5P, ZK-D-5Q, ZK-D-5R, ZK-D-5S, ZK-D-5T, ZK-D-5U, ZK-D-5V, ZK-D-5W, ZK-D-5X, ZK-D-5Y, ZK-D-5Z

Test Results:
EMC: PASS

TEST RESULT CERTIFICATION

Applicant Name: Shaoxing Zhikang Drive Technology Co., Ltd.
Address: 68 Kafi Road, Shaoxing, Zhejiang
Manufacturer Name: Shaoxing Zhikang Drive Technology Co., Ltd.
Product Description: electric office height adjustable desk
Brand Name: N/A
Model Name: ZK-D-2A, ZK-D-3A, ZK-D-3B, ZK-D-3C, ZK-D-3D, ZK-D-3E, ZK-D-3F, ZK-D-3G, ZK-D-3H, ZK-D-3I, ZK-D-3J, ZK-D-3K, ZK-D-3L, ZK-D-3M, ZK-D-3N, ZK-D-3O, ZK-D-3P, ZK-D-3Q, ZK-D-3R, ZK-D-3S, ZK-D-3T, ZK-D-3U, ZK-D-3V, ZK-D-3W, ZK-D-3X, ZK-D-3Y, ZK-D-3Z, ZK-D-4A, ZK-D-4B, ZK-D-4C, ZK-D-4D, ZK-D-4E, ZK-D-4F, ZK-D-4G, ZK-D-4H, ZK-D-4I, ZK-D-4J, ZK-D-4K, ZK-D-4L, ZK-D-4M, ZK-D-4N, ZK-D-4O, ZK-D-4P, ZK-D-4Q, ZK-D-4R, ZK-D-4S, ZK-D-4T, ZK-D-4U, ZK-D-4V, ZK-D-4W, ZK-D-4X, ZK-D-4Y, ZK-D-4Z, ZK-D-5A, ZK-D-5B, ZK-D-5C, ZK-D-5D, ZK-D-5E, ZK-D-5F, ZK-D-5G, ZK-D-5H, ZK-D-5I, ZK-D-5J, ZK-D-5K, ZK-D-5L, ZK-D-5M, ZK-D-5N, ZK-D-5O, ZK-D-5P, ZK-D-5Q, ZK-D-5R, ZK-D-5S, ZK-D-5T, ZK-D-5U, ZK-D-5V, ZK-D-5W, ZK-D-5X, ZK-D-5Y, ZK-D-5Z
Test Standards: EN 621-1:2011, EN 621-2:2018
Date of Test: 27 Oct. 2020
Date of Expiry of Validity: 27 Oct. 2021
Date of Issue: 27 Oct. 2021
Test Result: Pass

Tested by: Scott Shen
Reviewed by: [Signature]
Approved by: [Signature]

Flux Compliance Service Laboratory

Test Result Certification

Certificate No.: FC02021100001
Product: electric office height adjustable desk
Model No.: ZK-D-2A, ZK-D-3A, ZK-D-3B, ZK-D-3C, ZK-D-3D, ZK-D-3E, ZK-D-3F, ZK-D-3G, ZK-D-3H, ZK-D-3I, ZK-D-3J, ZK-D-3K, ZK-D-3L, ZK-D-3M, ZK-D-3N, ZK-D-3O, ZK-D-3P, ZK-D-3Q, ZK-D-3R, ZK-D-3S, ZK-D-3T, ZK-D-3U, ZK-D-3V, ZK-D-3W, ZK-D-3X, ZK-D-3Y, ZK-D-3Z, ZK-D-4A, ZK-D-4B, ZK-D-4C, ZK-D-4D, ZK-D-4E, ZK-D-4F, ZK-D-4G, ZK-D-4H, ZK-D-4I, ZK-D-4J, ZK-D-4K, ZK-D-4L, ZK-D-4M, ZK-D-4N, ZK-D-4O, ZK-D-4P, ZK-D-4Q, ZK-D-4R, ZK-D-4S, ZK-D-4T, ZK-D-4U, ZK-D-4V, ZK-D-4W, ZK-D-4X, ZK-D-4Y, ZK-D-4Z, ZK-D-5A, ZK-D-5B, ZK-D-5C, ZK-D-5D, ZK-D-5E, ZK-D-5F, ZK-D-5G, ZK-D-5H, ZK-D-5I, ZK-D-5J, ZK-D-5K, ZK-D-5L, ZK-D-5M, ZK-D-5N, ZK-D-5O, ZK-D-5P, ZK-D-5Q, ZK-D-5R, ZK-D-5S, ZK-D-5T, ZK-D-5U, ZK-D-5V, ZK-D-5W, ZK-D-5X, ZK-D-5Y, ZK-D-5Z

Test Standards: EN 60204-1:2000, EN 62777:2014+A1:2019
Test Result: EN 60204-1:2000 T11 12010, EN 62777:2014+A1:2019, EN 61010-1:2017 T11 12010

Approved by: [Signature]
Date: 27 Oct. 2021

THANKS

— www.cnstandingdesk.com —